

**K8T800/K8M800**

	VSUS_NB
K8T800	2.5V
K8M800	1.5V
K8T800B	1.5V

**VDDQ**

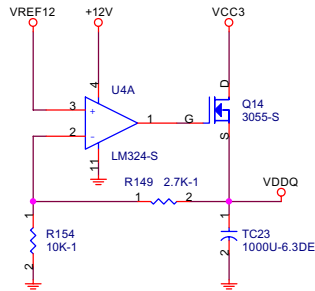

**VCC25A**

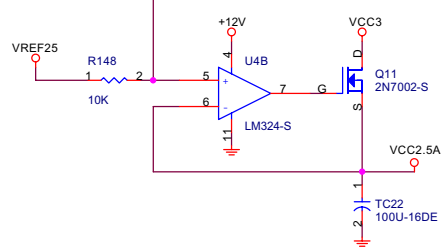

**VCC12**

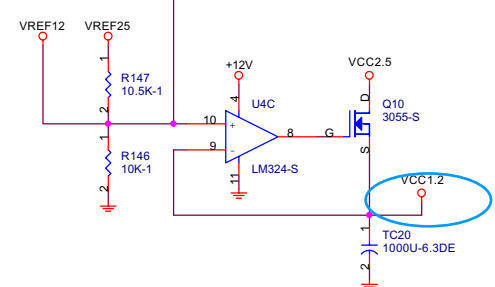

**VCC25**

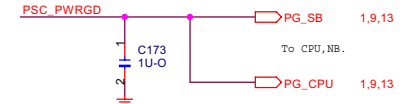
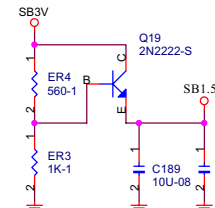
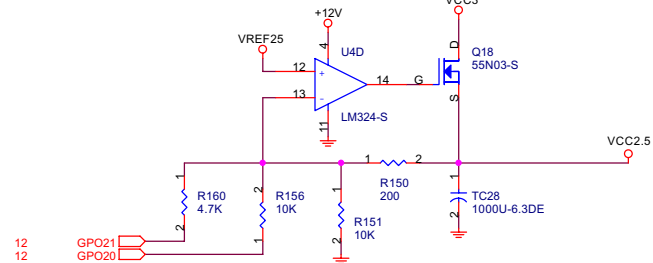

**DDRVTT**

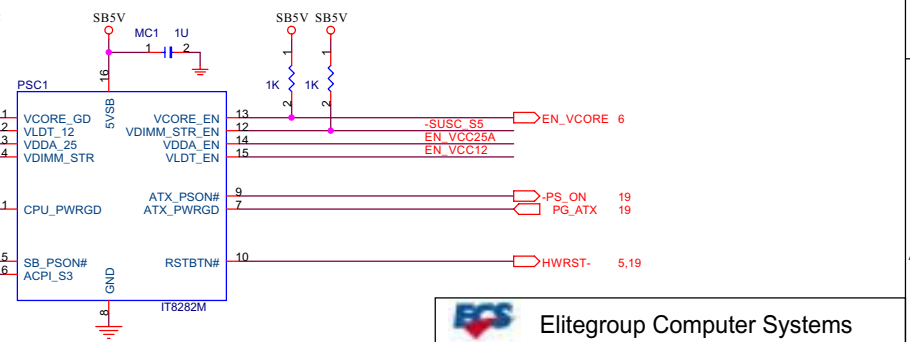
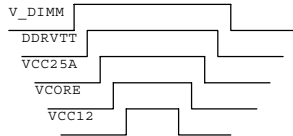
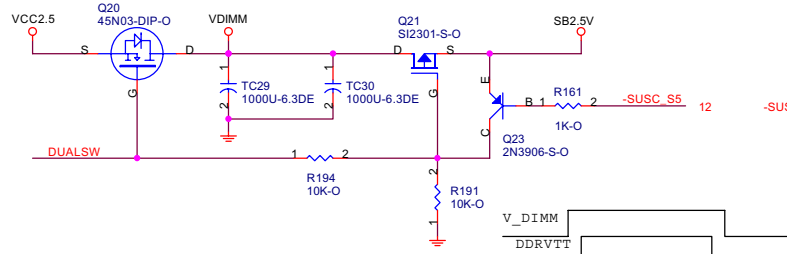
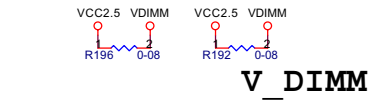
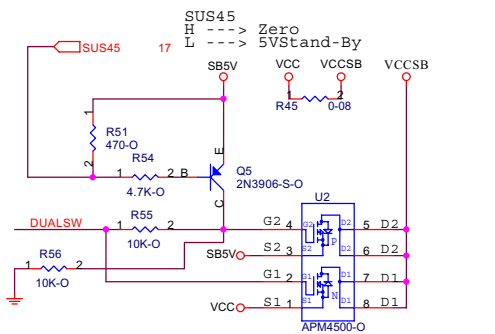
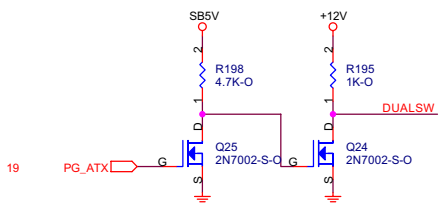
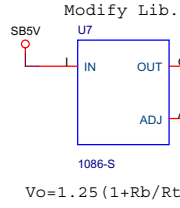
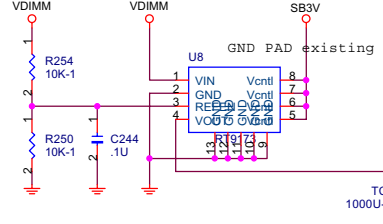

**Elitegroup Computer Systems**

Title: **Power (DC to DC)**

Size: Document Number **K8M800-M2** Rev **2.0**

Custom: **Friday, August 19, 2005** Sheet **7** of **22**