

PNP Silicon RF Transistor

- For broadband amplifiers up to 2GHz at collector currents up to 20mA
- Complementary type: BFR 92P (NPN)



ESD: Electrostatic discharge sensitive device, observe handling precaution!

Type	Marking	Ordering Code	Pin Configuration			Package
BFT 92	W1s	Q62702-F1062	1 = B	2 = E	3 = C	SOT-23

Maximum Ratings

Parameter	Symbol	Values	Unit
Collector-emitter voltage	V_{CEO}	15	V
Collector-base voltage	V_{CBO}	20	
Emitter-base voltage	V_{EBO}	2	
Collector current	I_C	25	mA
Base current	I_B	3	
Total power dissipation $T_S \leq 78\text{ °C}$	P_{tot}	200	mW
Junction temperature	T_j	150	°C
Ambient temperature	T_A	- 65 ... + 150	
Storage temperature	T_{stg}	- 65 ... + 150	

Thermal Resistance

Junction - soldering point ¹⁾	R_{thJS}	≤ 360	K/W
--	------------	------------	-----

1) T_S is measured on the collector lead at the soldering point to the pcb.

Electrical Characteristics at $T_A = 25^\circ\text{C}$, unless otherwise specified.

Parameter	Symbol	Values			Unit
		min.	typ.	max.	
DC Characteristics					
Collector-emitter breakdown voltage $I_C = 1 \text{ mA}, I_B = 0$	$V_{(BR)CEO}$	15	-	-	V
Collector-base cutoff current $V_{CB} = 10 \text{ V}, I_E = 0$	I_{CBO}	-	-	100	nA
Emitter-base cutoff current $V_{EB} = 2 \text{ V}, I_C = 0$	I_{EBO}	-	-	10	μA
DC current gain $I_C = 15 \text{ mA}, V_{CE} = 8 \text{ V}$	h_{FE}	15	50	-	-

Electrical Characteristics at $T_A = 25^\circ\text{C}$, unless otherwise specified.

Parameter	Symbol	Values			Unit
		min.	typ.	max.	
AC Characteristics					
Transition frequency $I_C = 15 \text{ mA}$, $V_{CE} = 8 \text{ V}$, $f = 500 \text{ MHz}$	f_T	3.5	5	-	GHz
Collector-base capacitance $V_{CB} = 10 \text{ V}$, $f = 1 \text{ MHz}$	C_{cb}	-	0.54	0.8	pF
Collector-emitter capacitance $V_{CE} = 10 \text{ V}$, $f = 1 \text{ MHz}$	C_{ce}	-	0.25	-	
Emitter-base capacitance $V_{EB} = 0.5 \text{ V}$, $f = 1 \text{ MHz}$	C_{eb}	-	0.77	-	
Noise figure $I_C = 2 \text{ mA}$, $V_{CE} = 8 \text{ V}$, $Z_S = Z_{Sopt}$ $f = 900 \text{ MHz}$ $f = 1.8 \text{ GHz}$	F	-	2 3.2	-	dB
Power gain ²⁾ $I_C = 15 \text{ mA}$, $V_{CE} = 8 \text{ V}$, $Z_S = Z_{Sopt}$ $Z_L = Z_{Lopt}$ $f = 900 \text{ MHz}$ $f = 1.8 \text{ GHz}$	G_{ma}	-	13.5 8	-	
Transducer gain $I_C = 15 \text{ mA}$, $V_{CE} = 8 \text{ V}$, $Z_S = Z_L = 50 \Omega$ $f = 900 \text{ MHz}$ $f = 1.8 \text{ GHz}$	$ S_{21e} ^2$	-	11.5 6	-	

2) $G_{ma} = |S_{21}/S_{12}| (k - (k^2 - 1)^{1/2})$

SPICE Parameters (Gummel-Poon Model, Berkeley-SPICE 2G.6 Syntax) :

Transistor Chip Data

IS =	4.5354	fA	BF =	98.533	-	NF =	0.90551	-
VAF =	10.983	V	IKF =	0.016123	A	ISE =	12.196	fA
NE =	1.1172	-	BR =	10.297	-	NR =	1.2703	-
VAR =	47.577	V	IKR =	0.019729	A	ISC =	0.024709	fA
NC =	1.206	-	RB =	7.9562	Ω	IRB =	0.79584	mA
RBM =	1.5939	Ω	RE =	1.5119	Ω	RC =	0.66749	Ω
CJE =	1.7785	fF	VJE =	0.79082	V	MJE =	0.32167	-
TF =	32.171	ps	XTF =	0.30227	-	VTF =	0.21451	V
ITF =	0.013277	mA	PTF =	0	deg	CJC =	922.07	fF
VJC =	1.2	V	MJC =	0.3	-	XCJC =	0.3	-
TR =	2.0779	ns	CJS =	0	fF	VJS =	0.75	V
MJS =	0	-	XTB =	0	-	EG =	1.11	eV
XTI =	3	-	FC =	0.75167	-	TNOM	300	K

All parameters are ready to use, no scaling is necessary.

Extracted on behalf of SIEMENS Small Signal Semiconductors by:
Institut für Mobil-und Satellitenfunktechnik (IMST)

© 1996 SIEMENS AG

Package Equivalent Circuit:

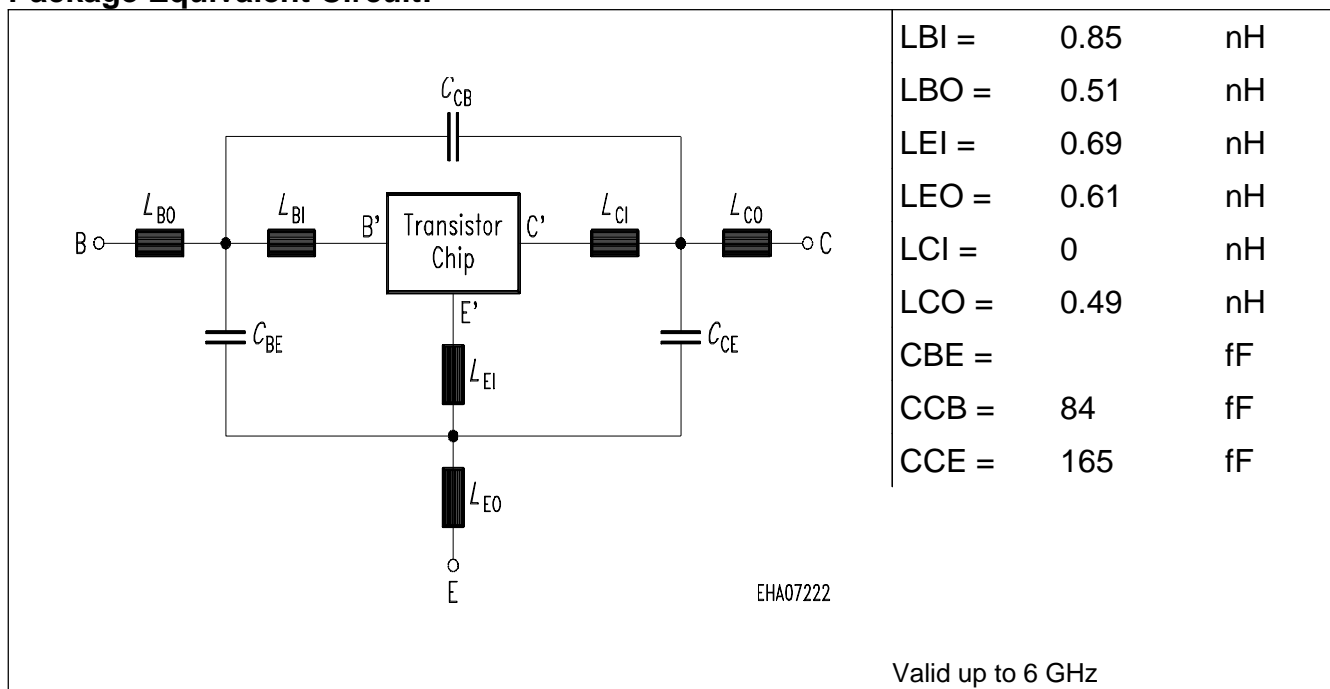

For examples and ready to use parameters please contact your local Siemens distributor or sales office to obtain a Siemens CD-ROM or see Internet: <http://www.siemens.de/Semiconductor/products/35/35.htm>

Total power dissipation $P_{tot} = f(T_A^*, T_S)$

* Package mounted on epoxy

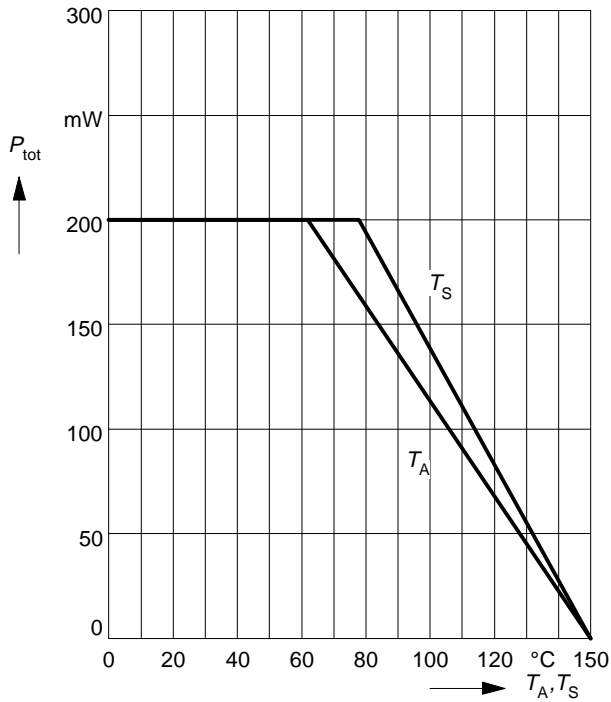

Permissible Pulse Load $R_{thJS} = f(t_p)$

Permissible Pulse Load $P_{totmax}/P_{totDC} = f(t_p)$

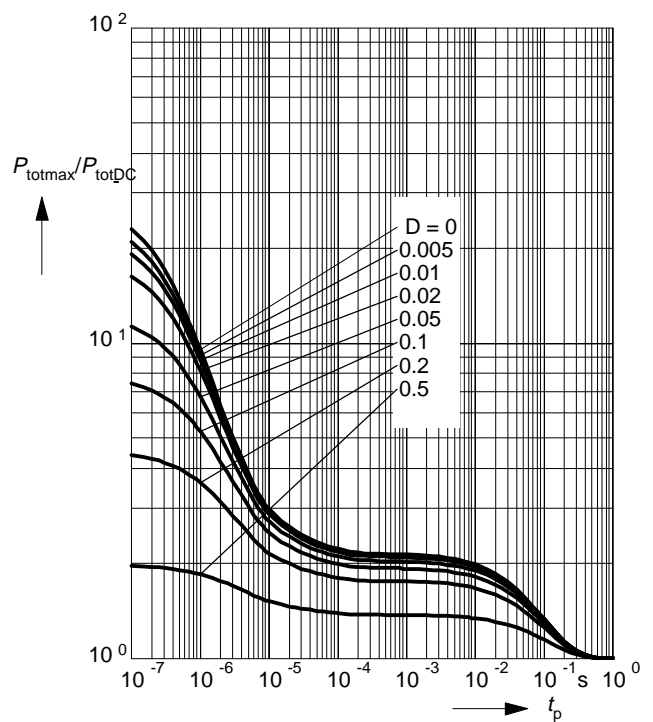
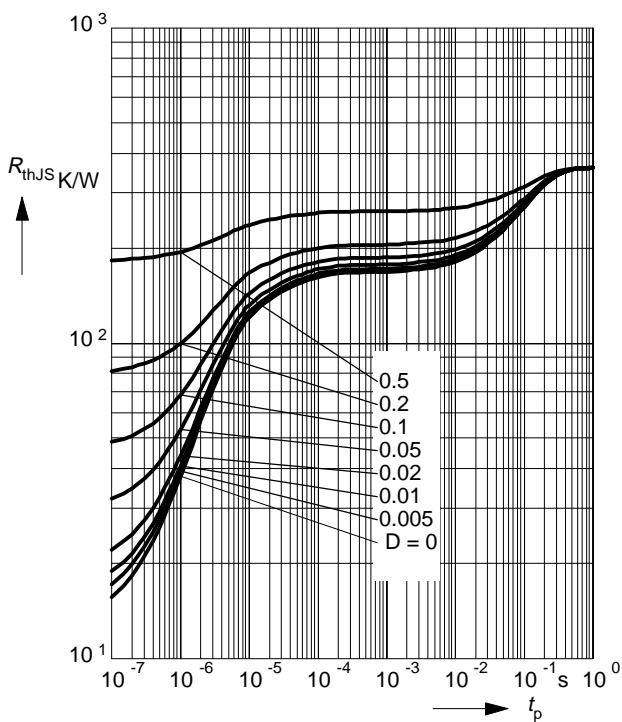

Collector-base capacitance $C_{cb} = f(V_{CB})$

$V_{BE} = v_{be} = 0, f = 1\text{MHz}$

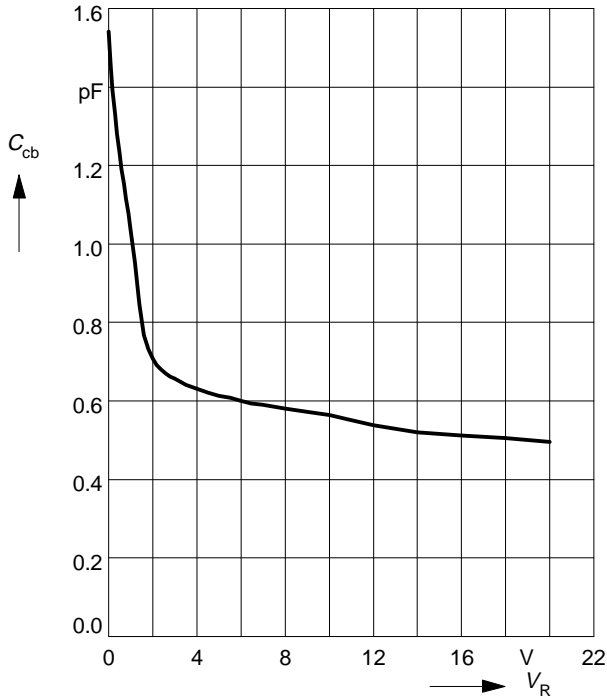

Transition frequency $f_T = f(I_C)$

$V_{CE} = \text{Parameter}$

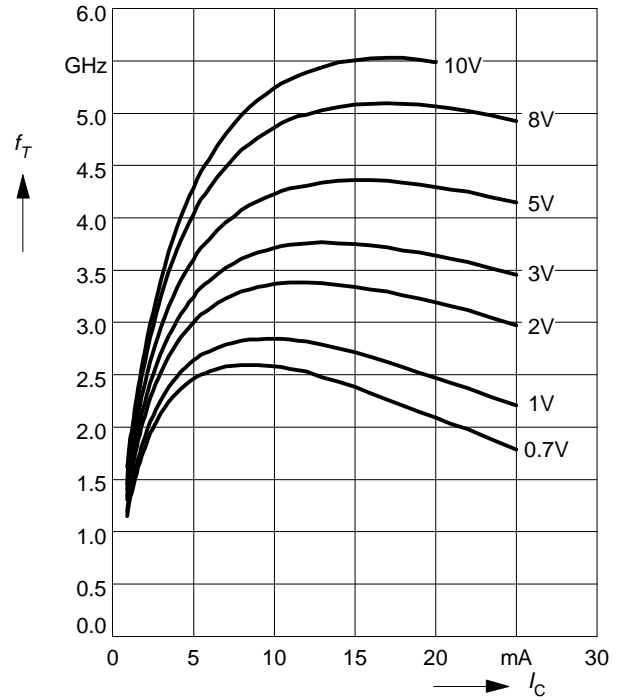

Power Gain $G_{ma}, G_{ms} = f(I_C)$

$f = 0.9\text{GHz}$

$V_{CE} = \text{Parameter}$

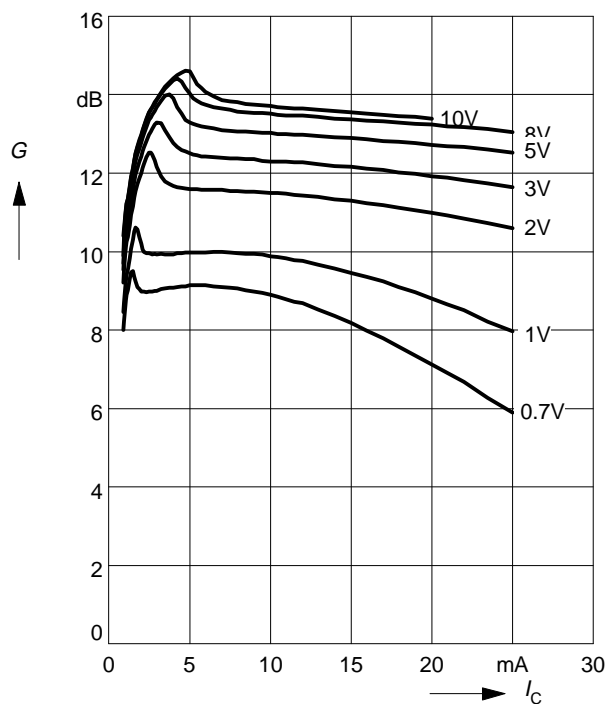

Power Gain $G_{ma}, G_{ms} = f(I_C)$

$f = 1.8\text{GHz}$

$V_{CE} = \text{Parameter}$

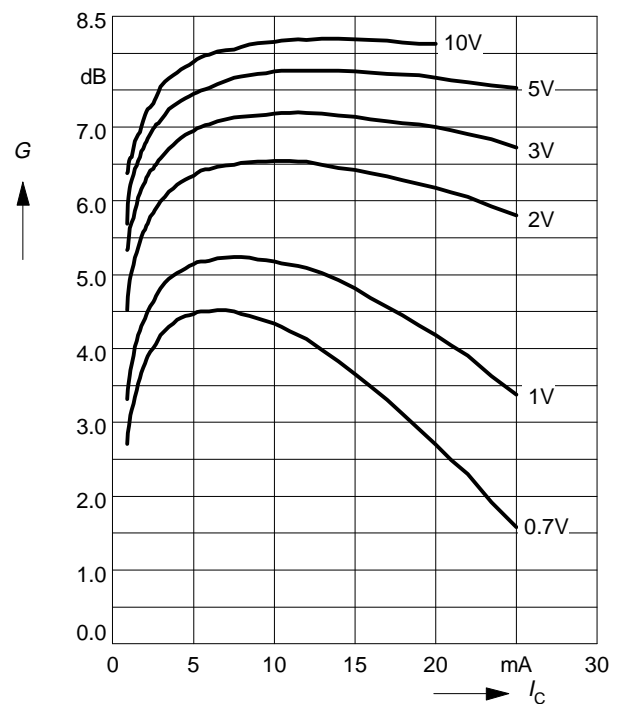

Power Gain $G_{ma}, G_{ms} = f(V_{CE})$: _____

$|S_{21}|^2 = f(V_{CE})$: - - - - -

f = Parameter

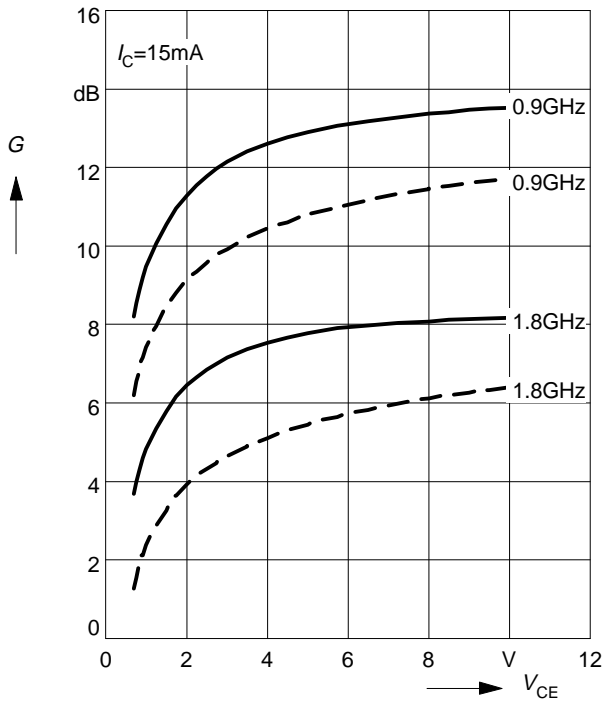

Intermodulation Intercept Point $IP_3 = f(I_C)$

(3rd order, Output, $Z_S = Z_L = 50\Omega$)

V_{CE} = Parameter, $f = 900\text{MHz}$

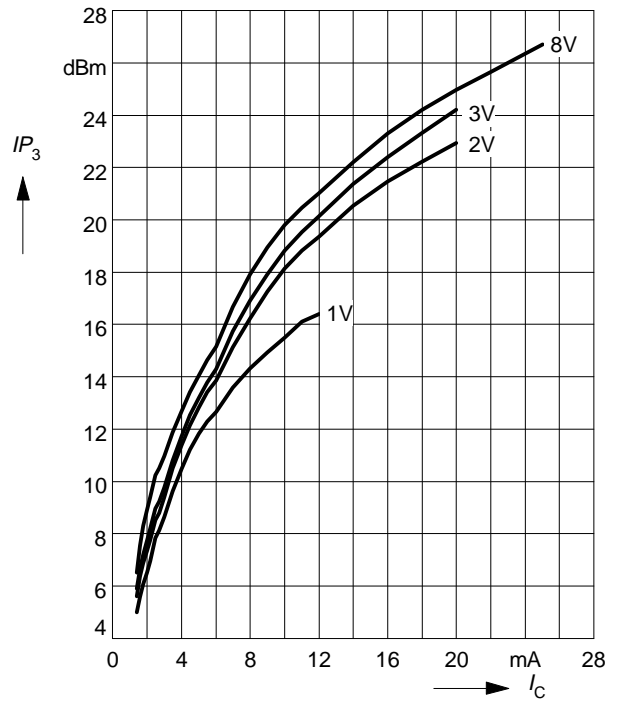

Power Gain $G_{ma}, G_{ms} = f(f)$

V_{CE} = Parameter

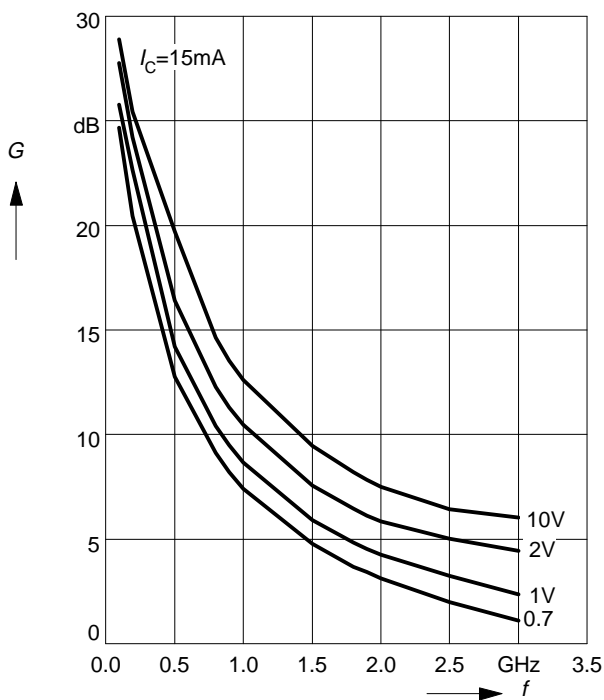

Power Gain $|S_{21}|^2 = f(f)$

V_{CE} = Parameter

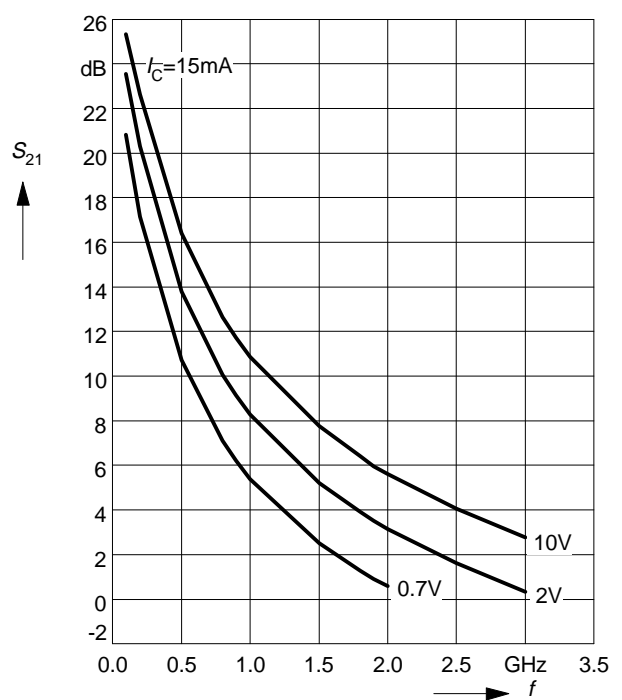

This datasheet has been download from:

www.datasheetcatalog.com

Datasheets for electronics components.