

RM-8/RM-47 top level

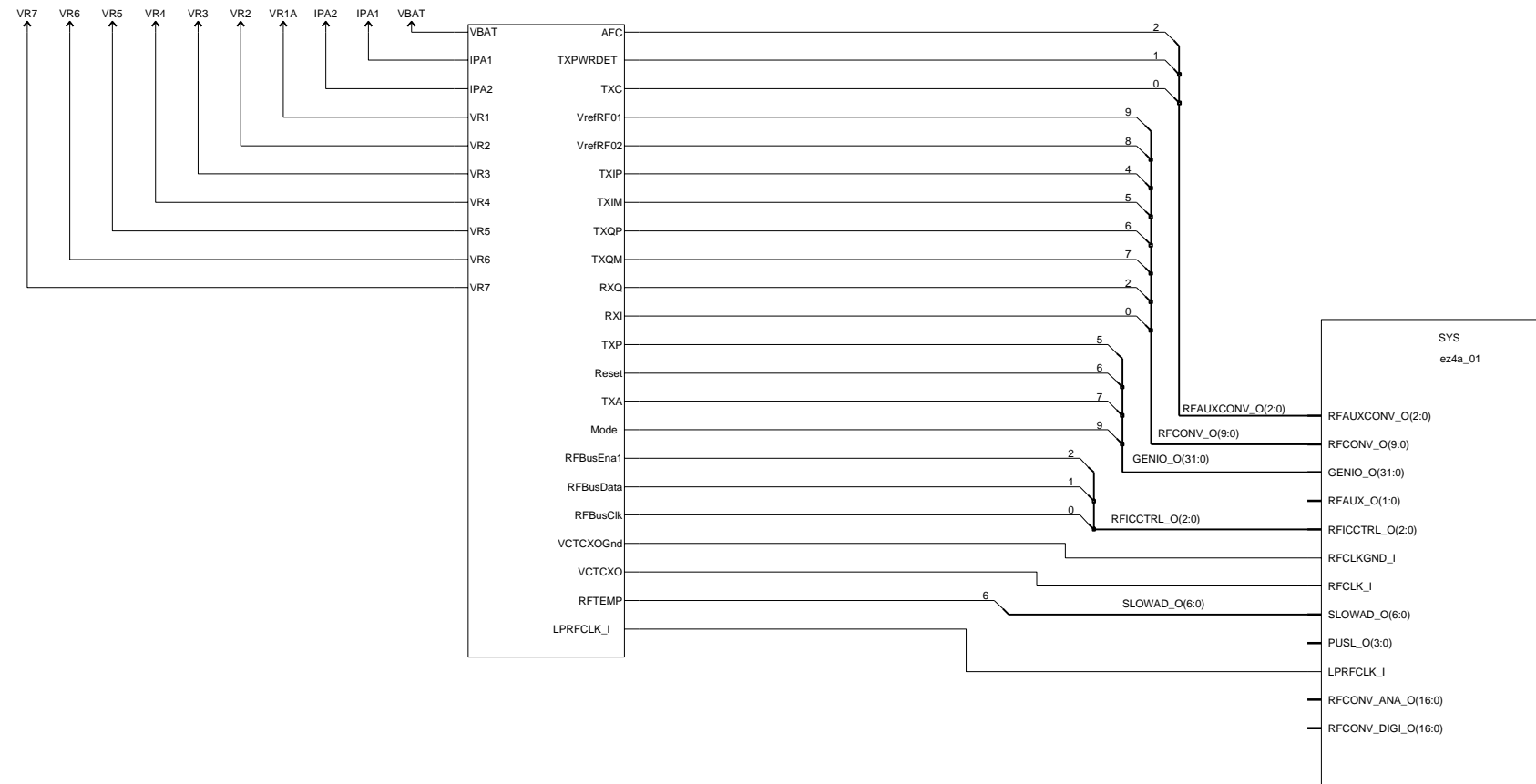

RF top level

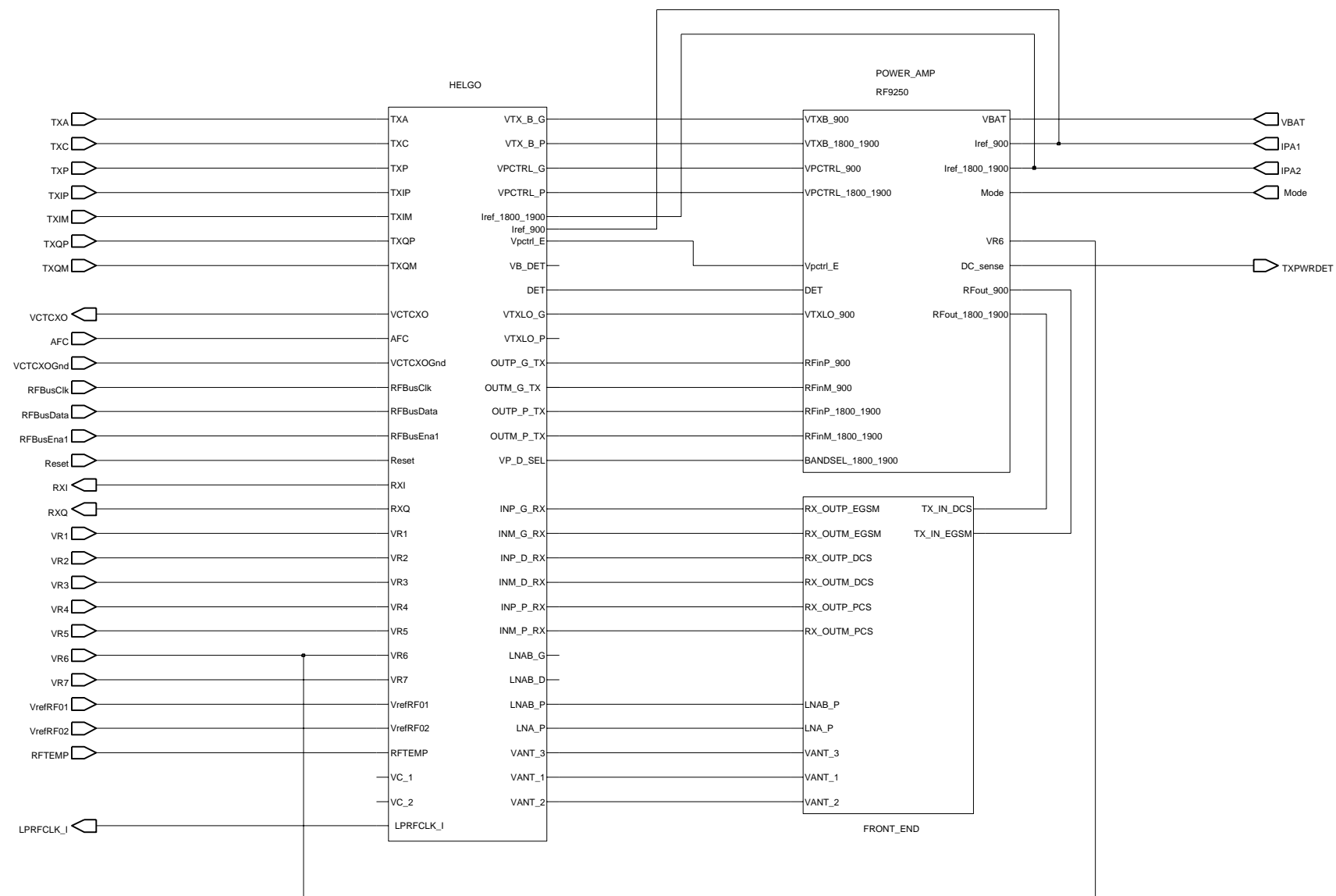

RF shields and vias

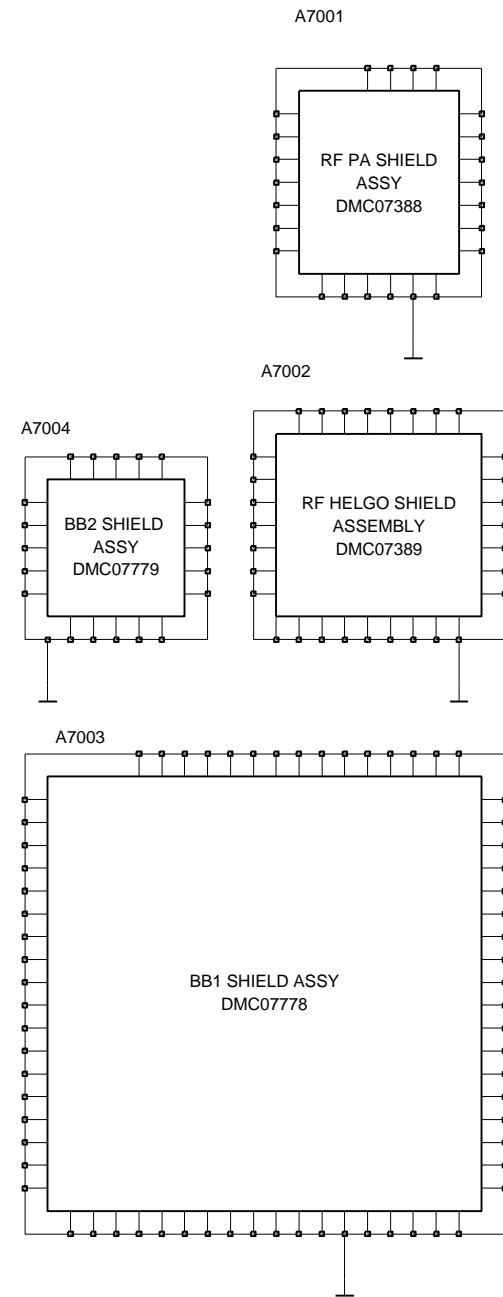

HELGO

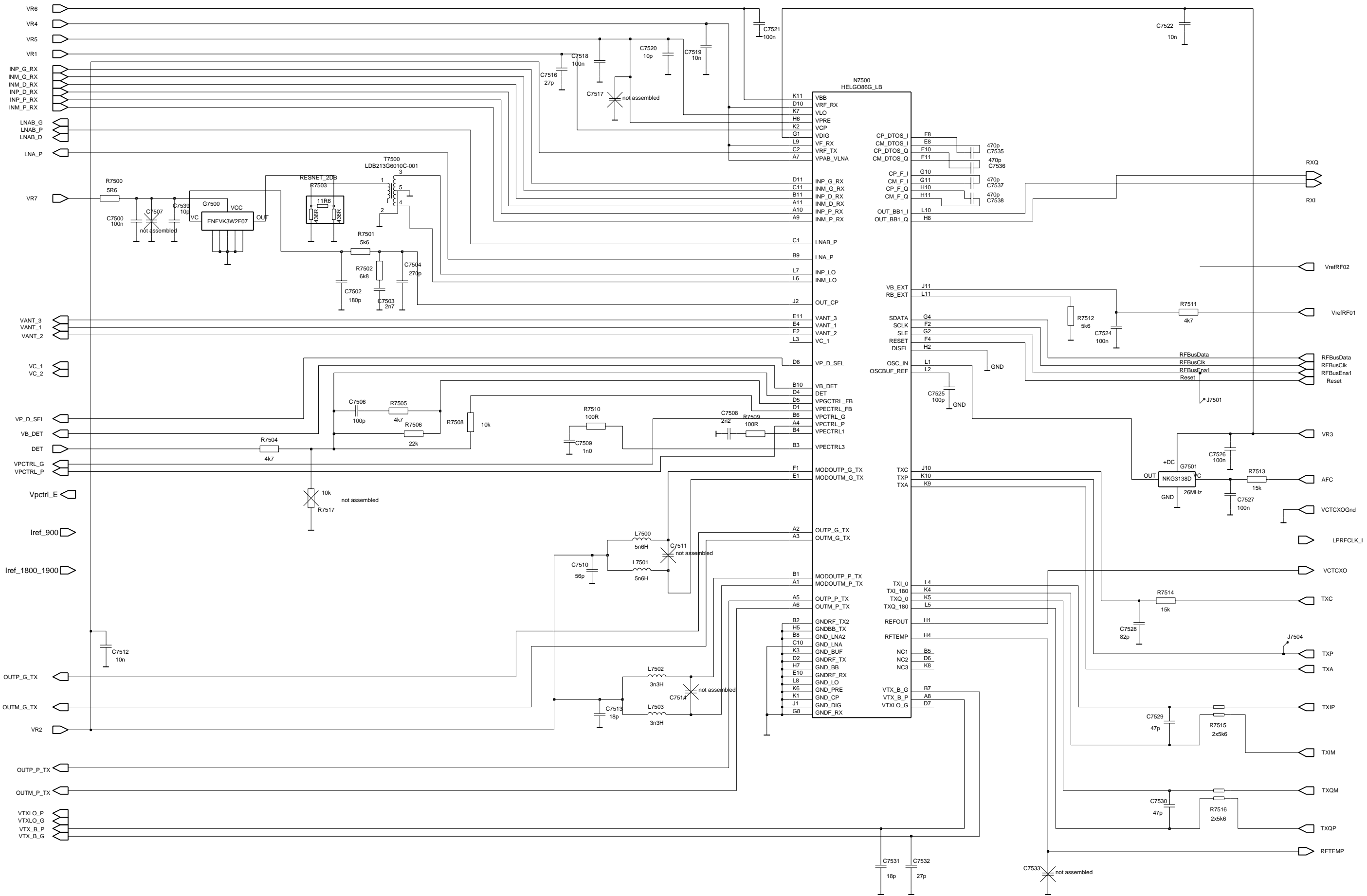

RX front end and antenna switch

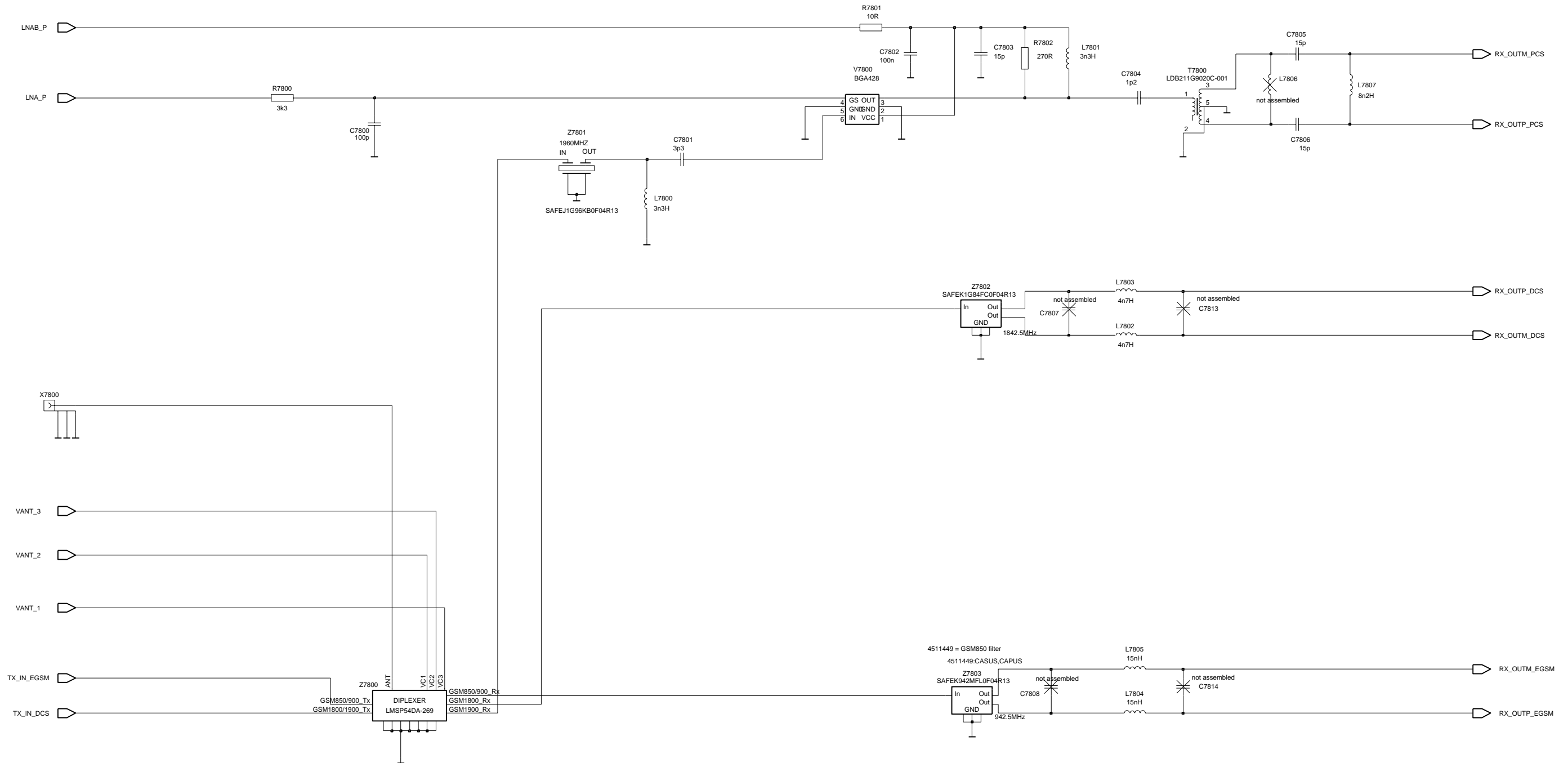

RFMD 9250 power amplifier and power detection

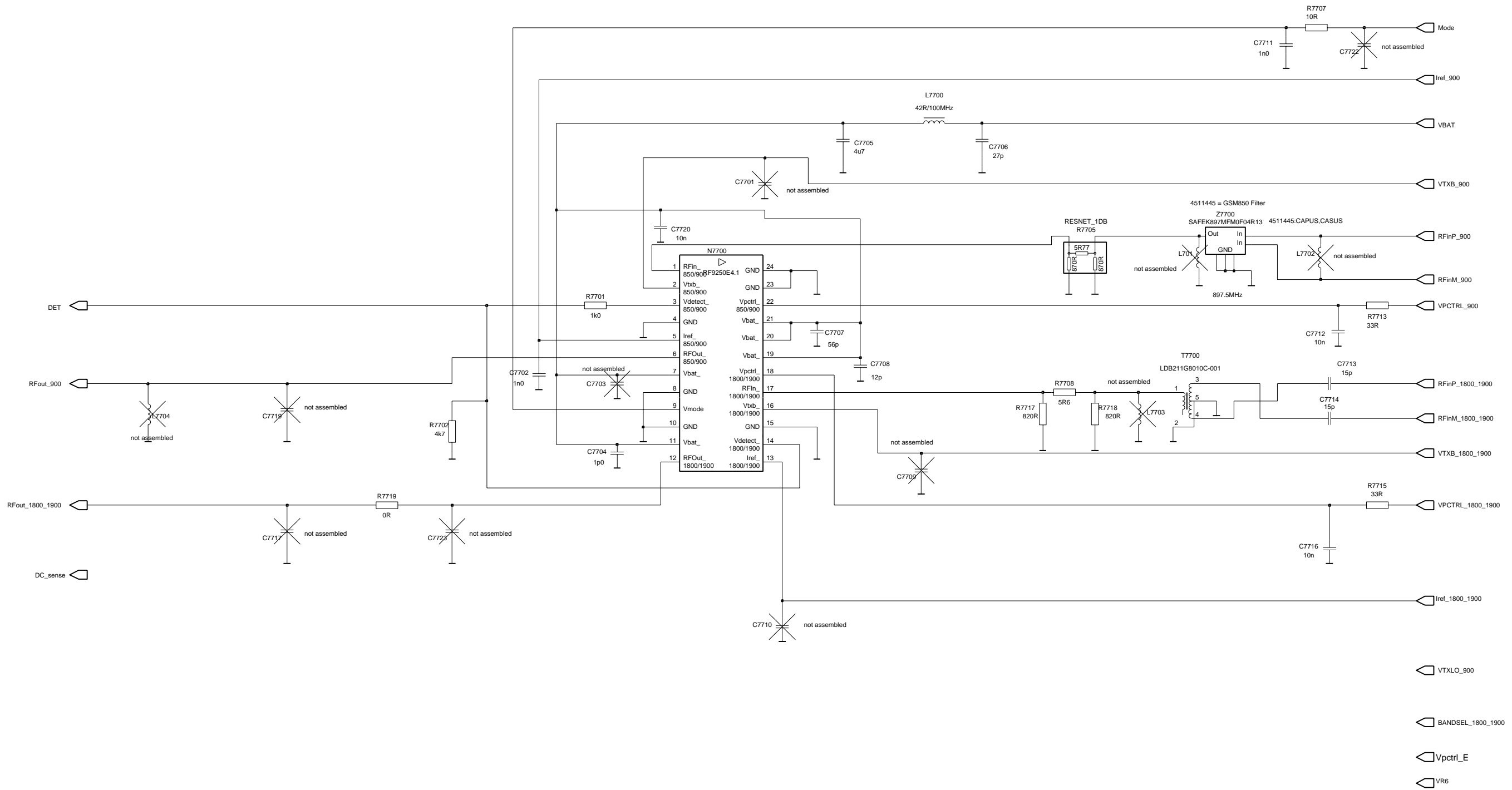

DCT45 common baseband top level

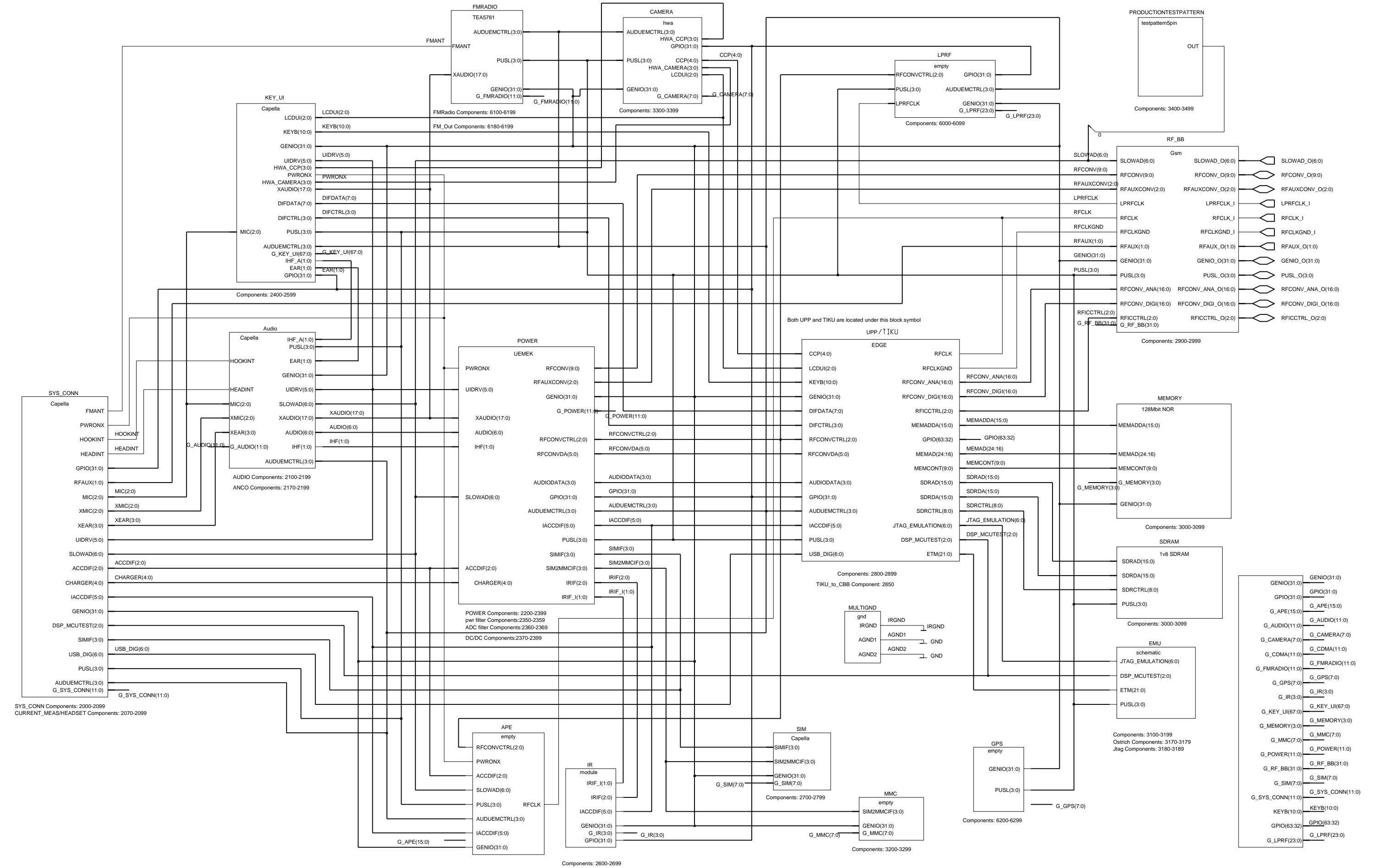

UEMEK power management

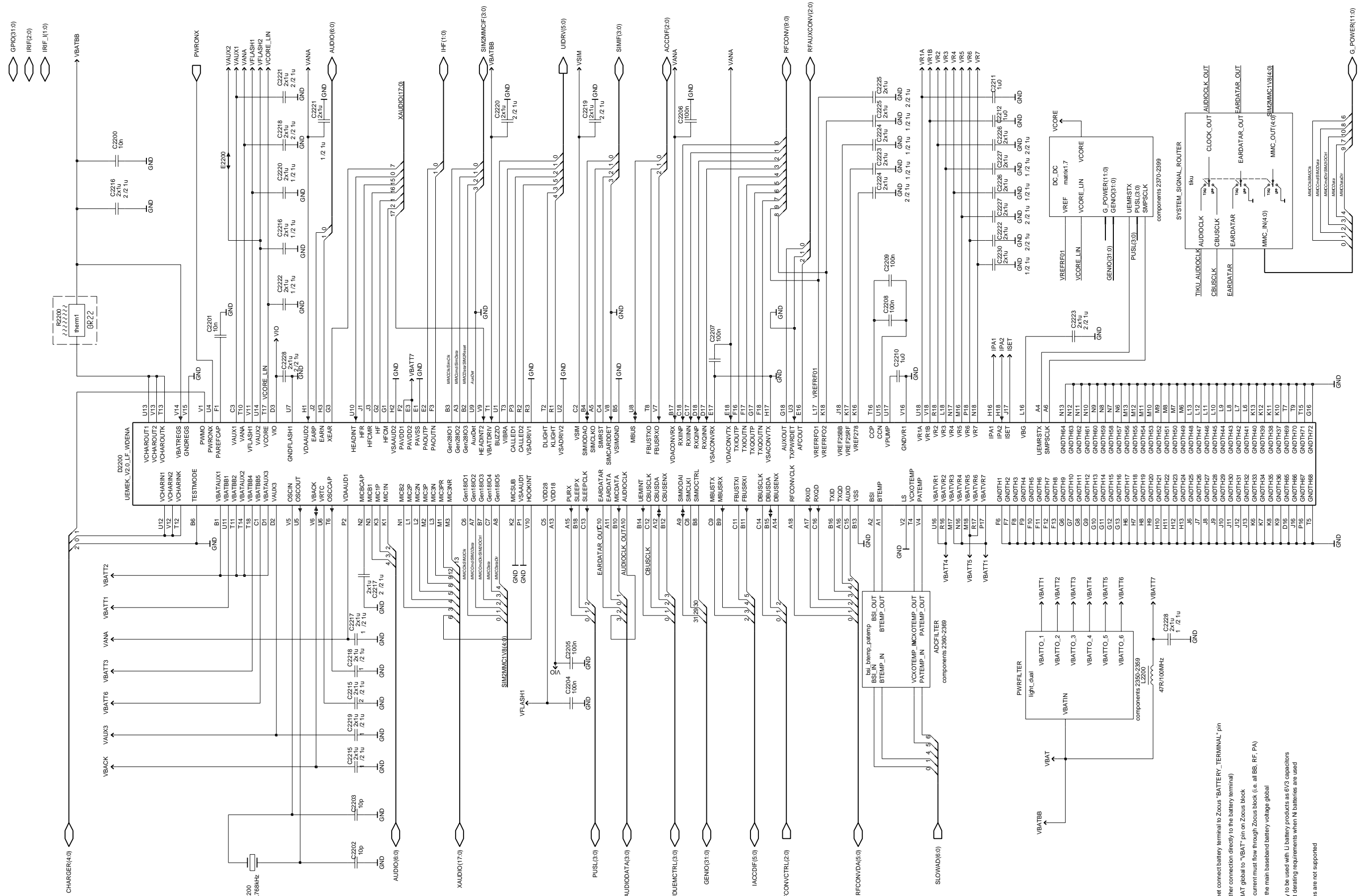

NOTE: On system sheet connect battery terminal to Zocus 'BATTERY_TERMINAL' pin (make no other connection directly to the battery terminal)
 Connect VBAT global to 'VBAT' pin on Zocus block
 ALL phone current must flow through Zocus block (i.e. all BB, RF, PA)
 VBATBB is the main baseband battery voltage global
 NOTE: This sheet only to be used with Li battery products as 6V3 capacitors do not meet derating requirements when Ni batteries are used
 NOTE: 2x8 IR modules are not supported

UEME ADC filter block

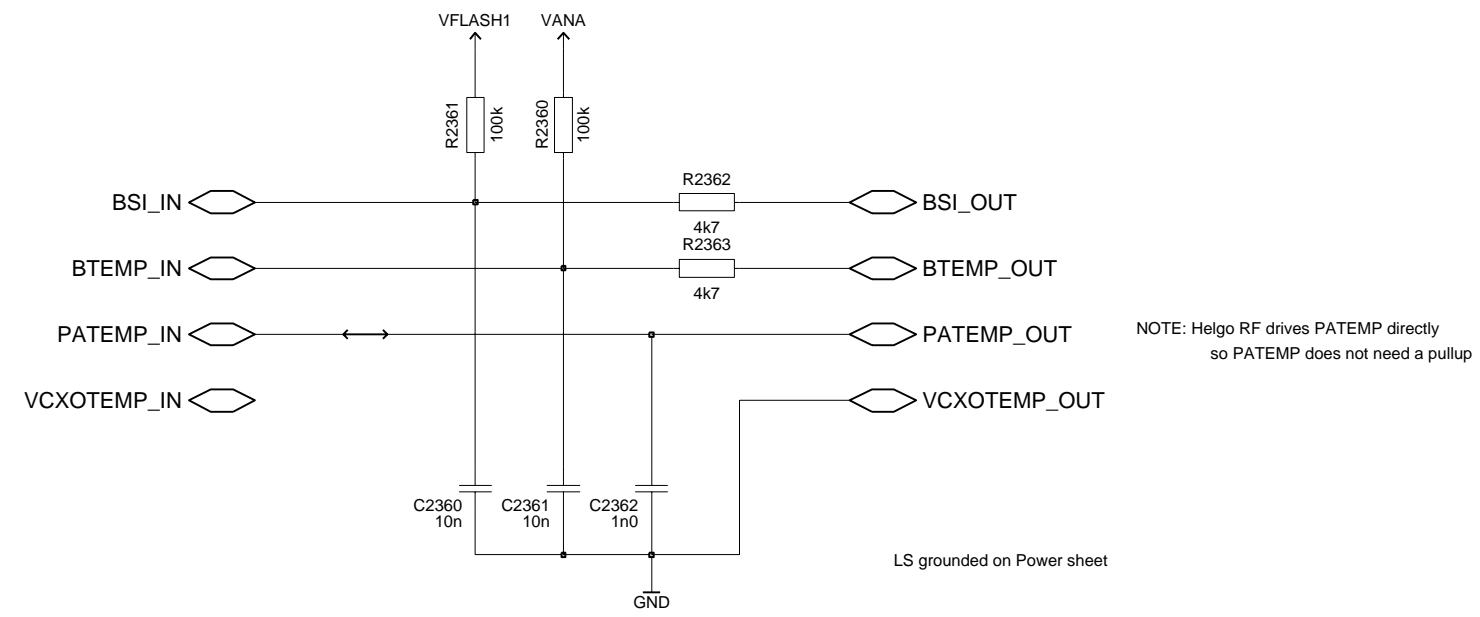

Light filtering

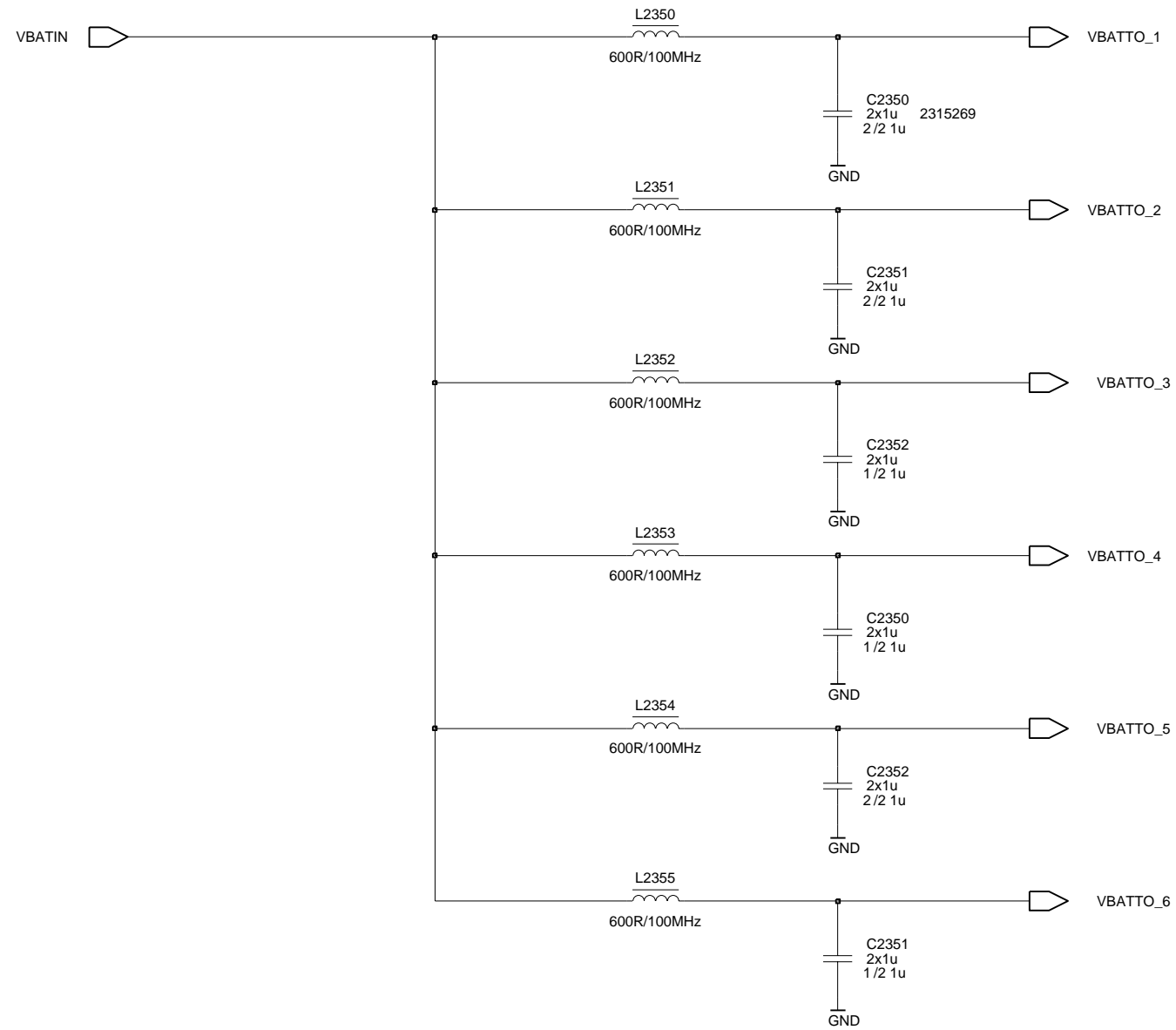

PWR resistor

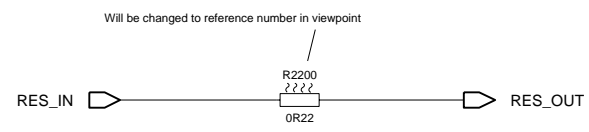

DC_DC for TIKU and VIO

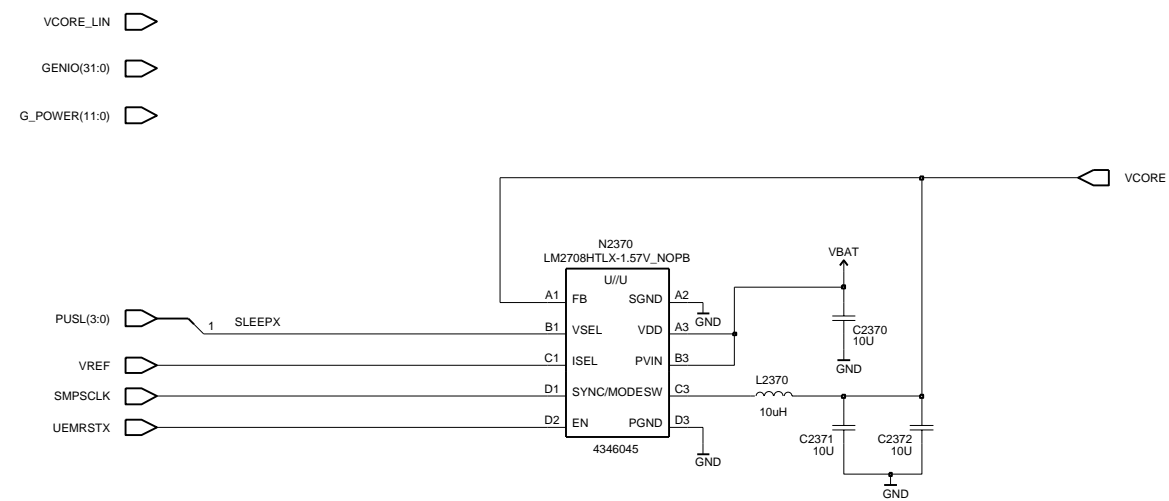

TEA 5761

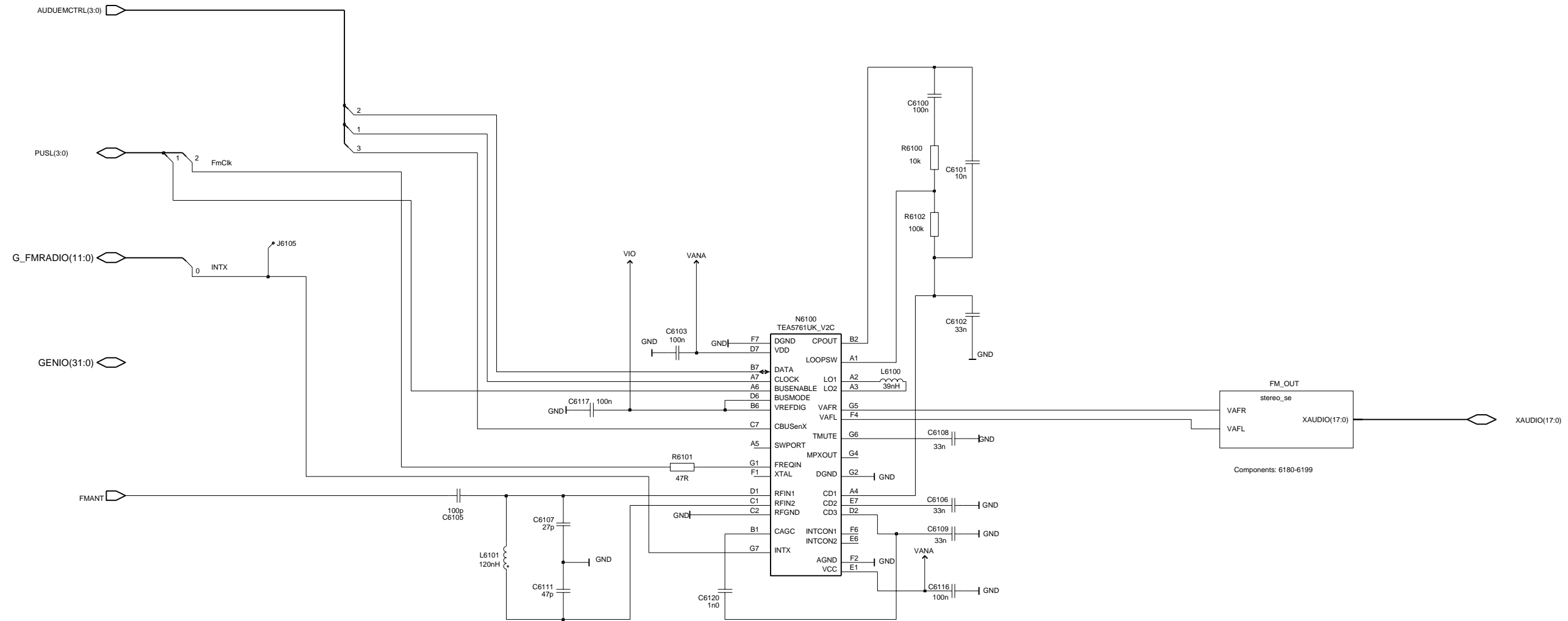

Differential stereo

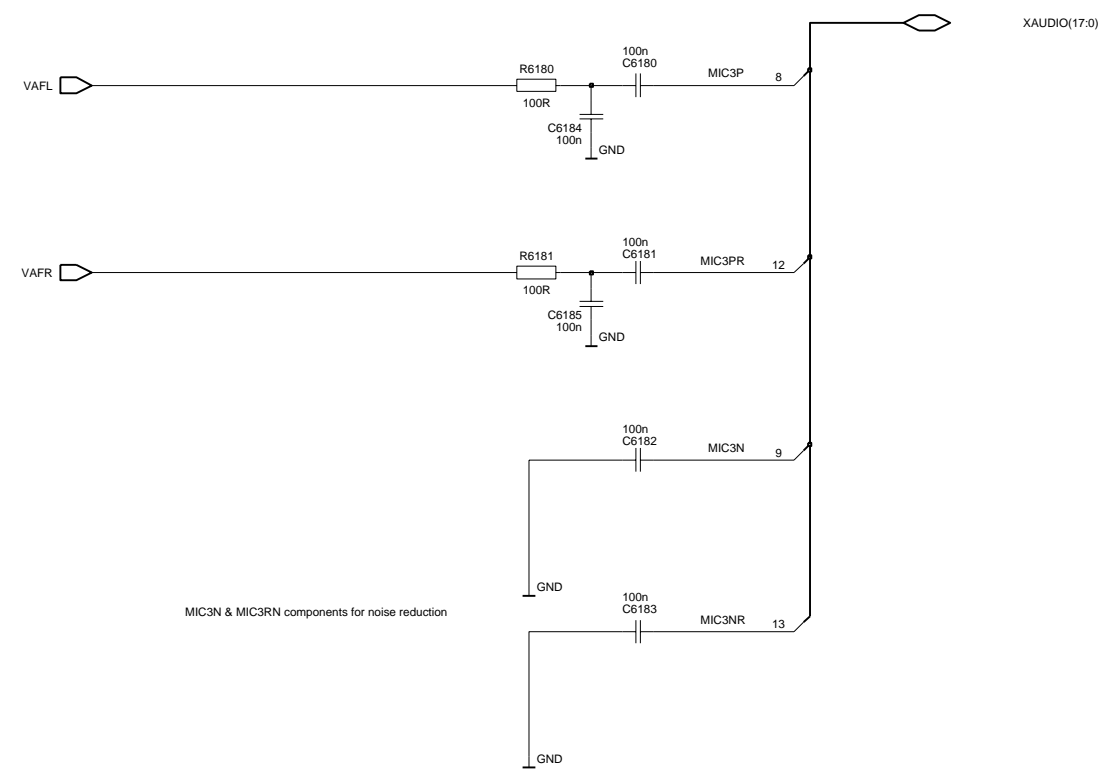

GENIO and GPIO connection block

TIKU GPIO & GENIO BUSES

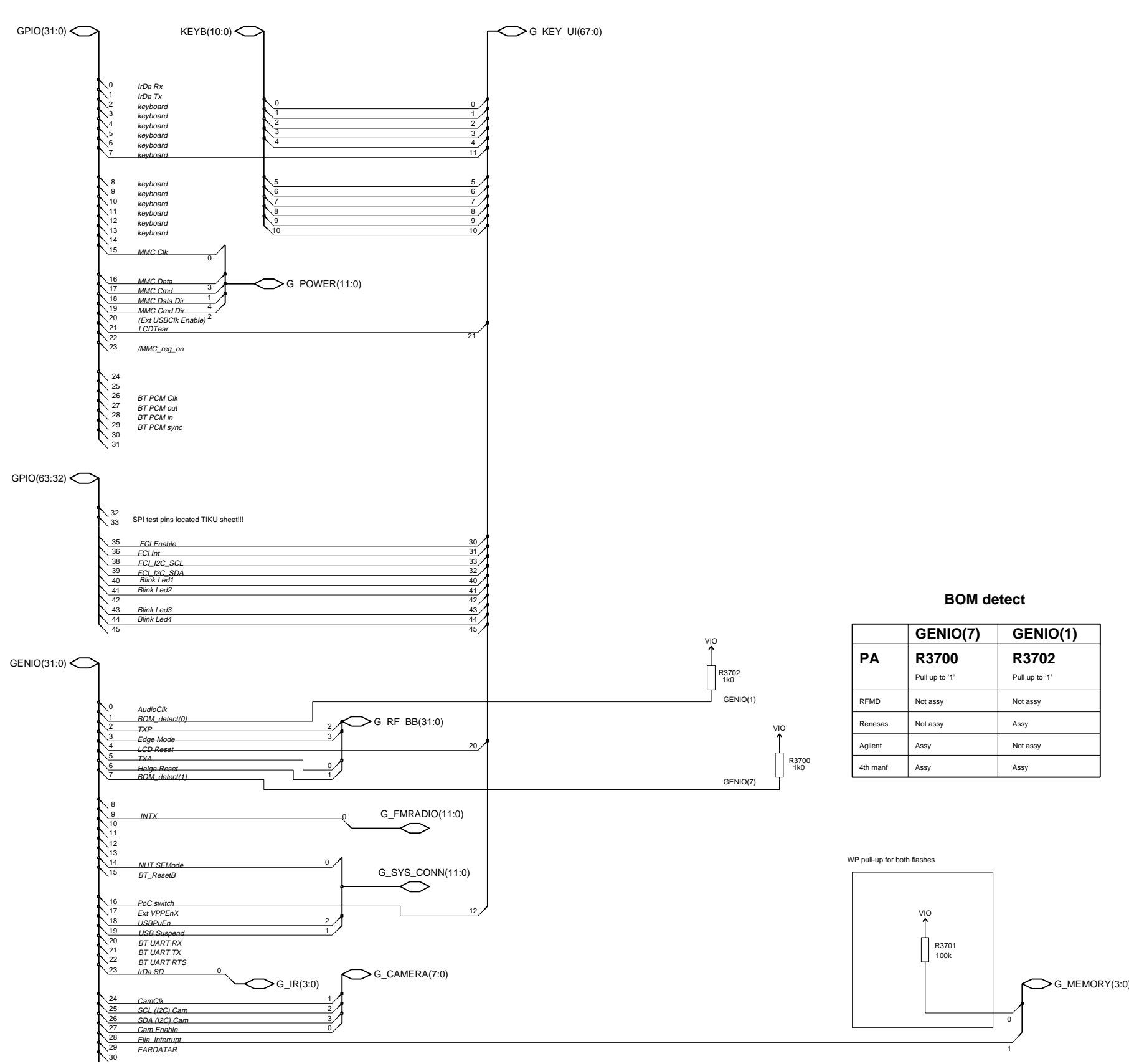

- ◊ G_APE(15:0)
- ◊ G_CDMA(11:0)
- ◊ G_GPS(7:0)
- ◊ G_SIM(7:0)
- ◊ G_MMC(7:0)
- ◊ G_LPRF(23:0)
- ◊ G_AUDIO(11:0)

BOM detect

	GENIO(7)	GENIO(1)
PA	R3700 Pull up to '1'	R3702 Pull up to '1'
RFMD	Not assy	Not assy
Renesas	Not assy	Assy
Agilent	Assy	Not assy
4th manf	Assy	Assy

WP pull-up for both flashes

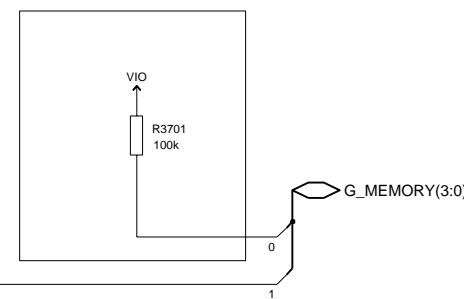

IR module

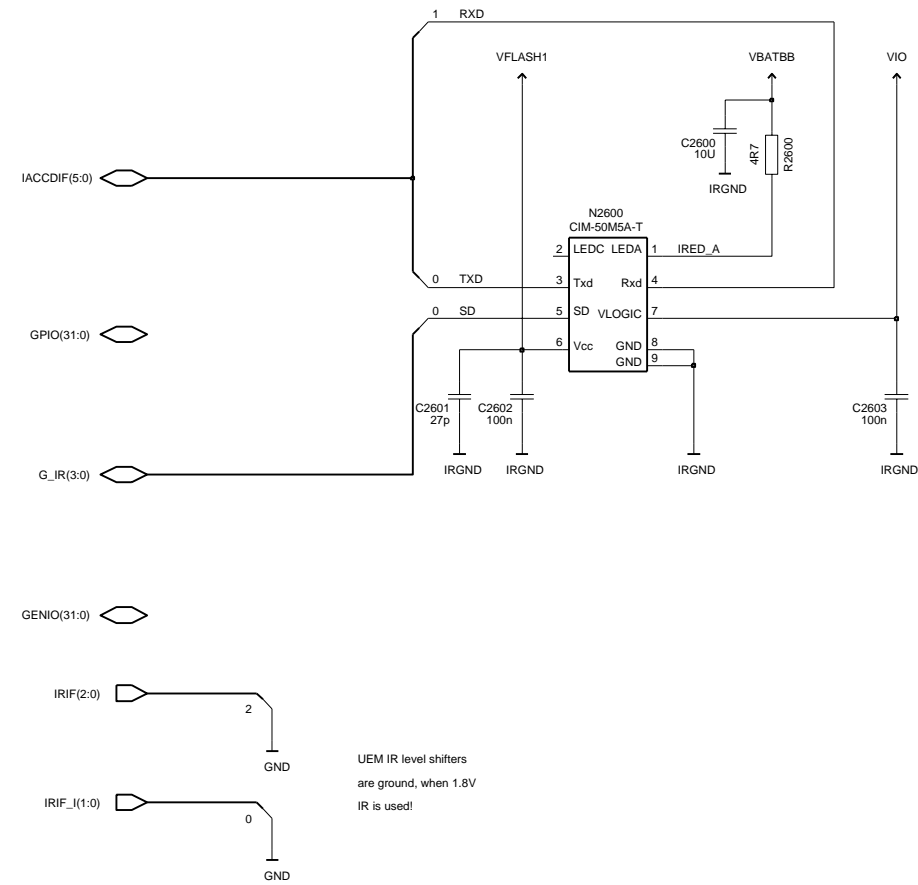

MultiGND symbol bypass

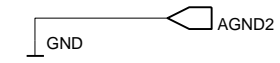
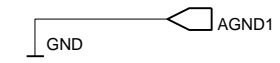
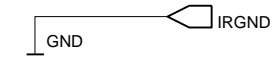

GSM RF - baseband interface

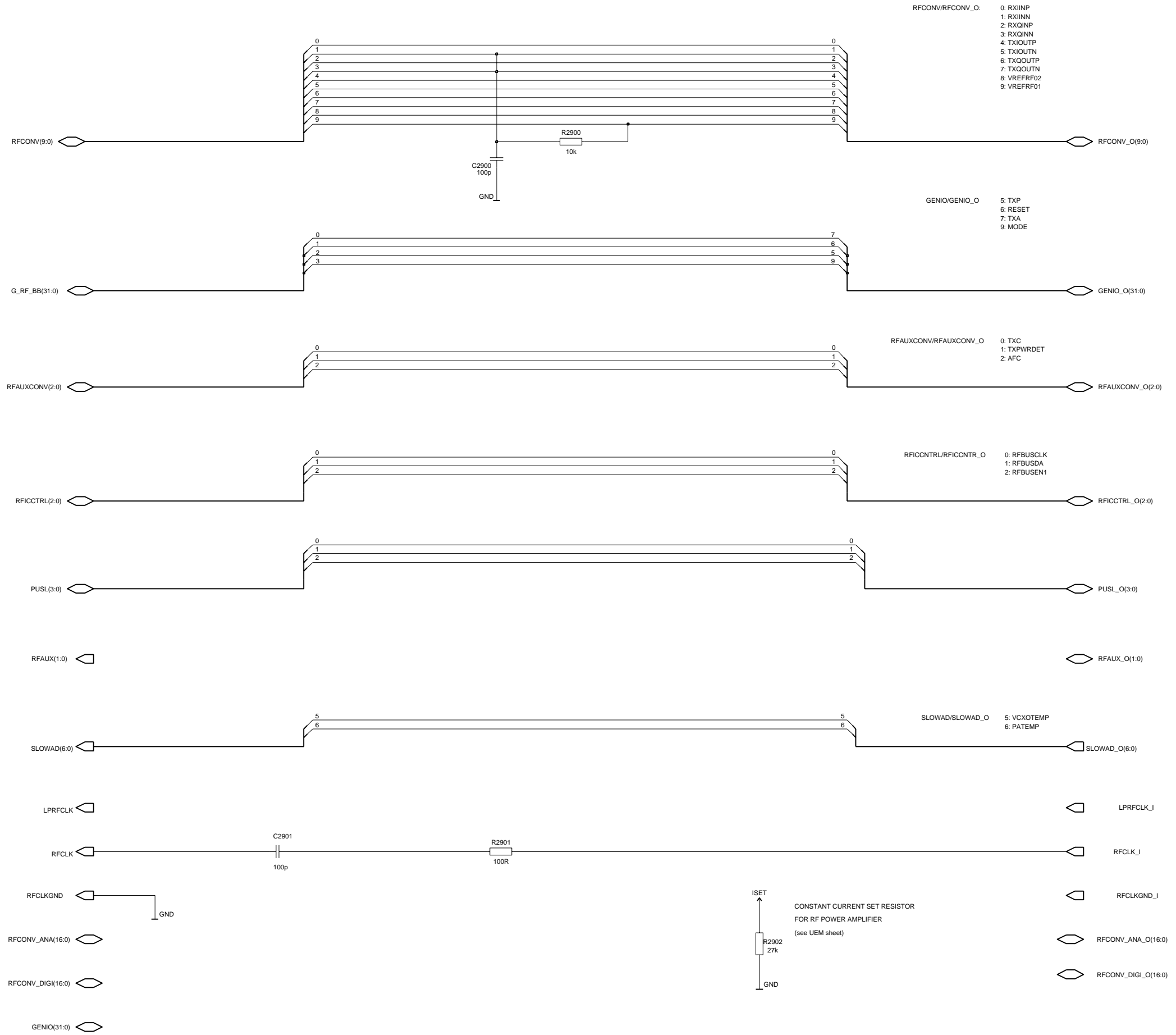

IPA1 AND IPA2 ARE USED IN RF, THE TOLERANCE OF R2902 IS 1% (0402, 1430873)

64Mbit 1v8 SDRAM memory

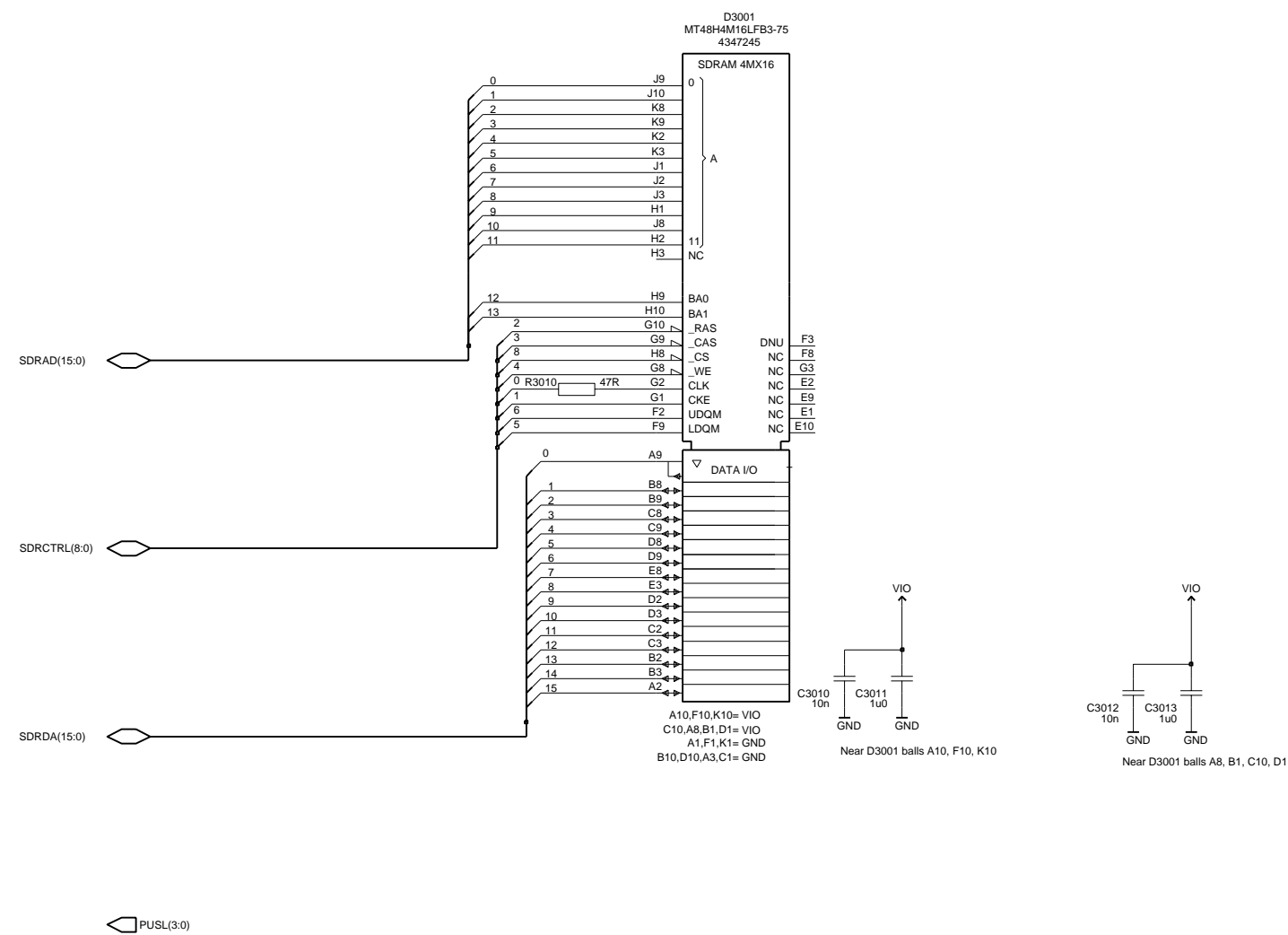

Testpoints based Ostrich interface

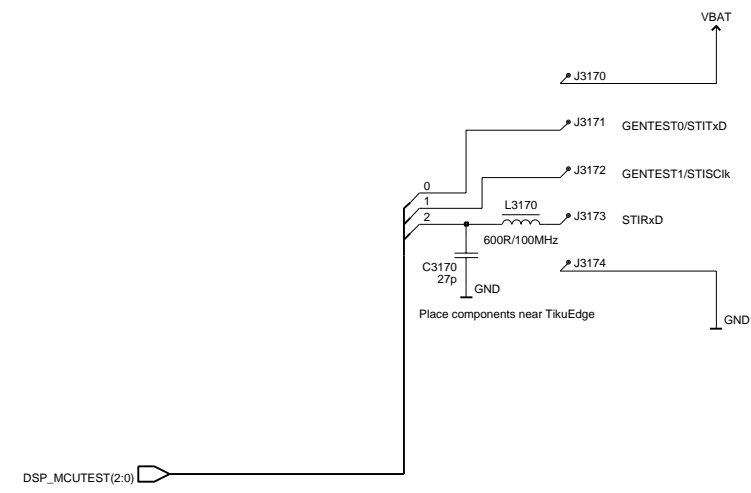

HWA

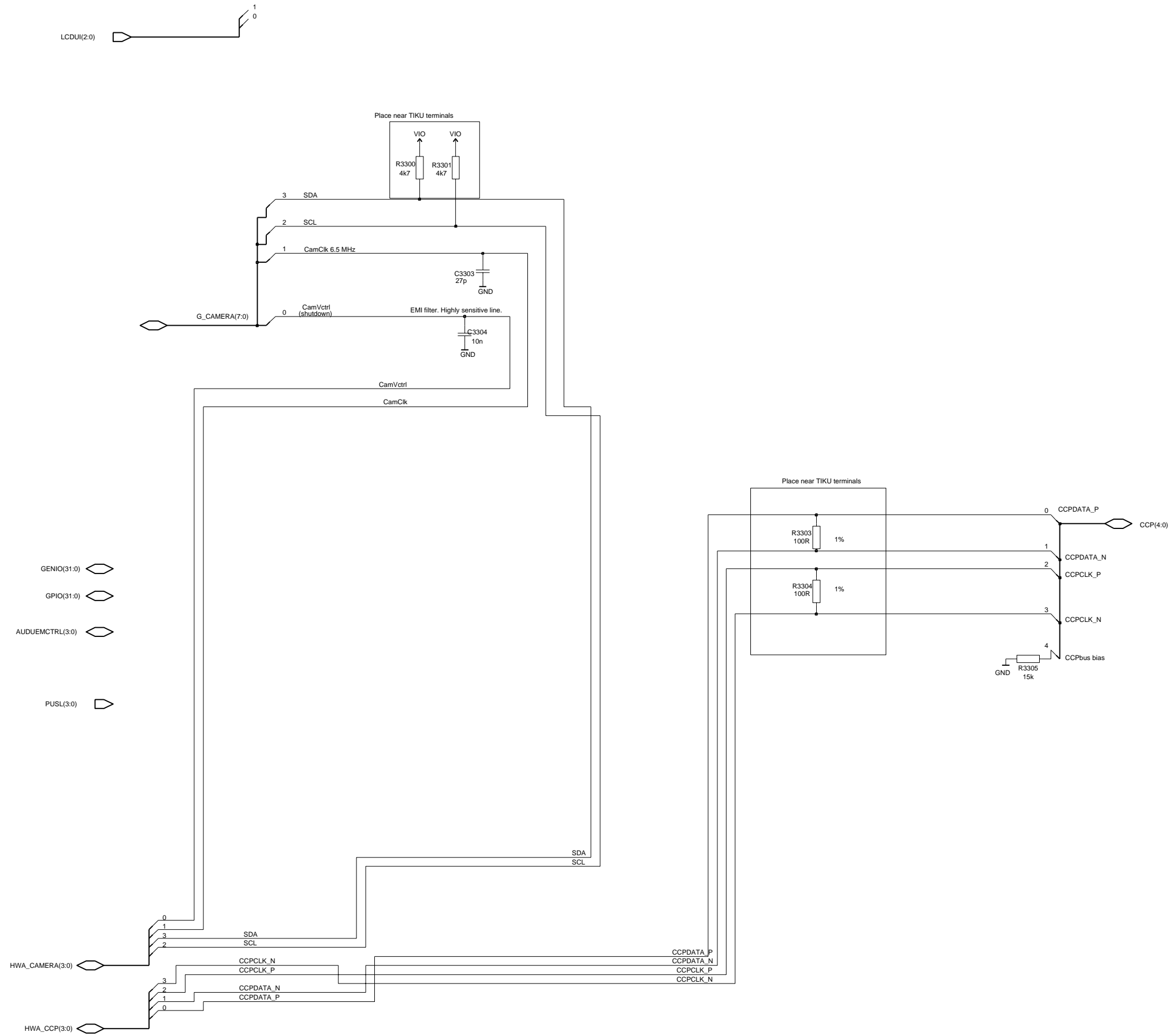

Br45 system connector

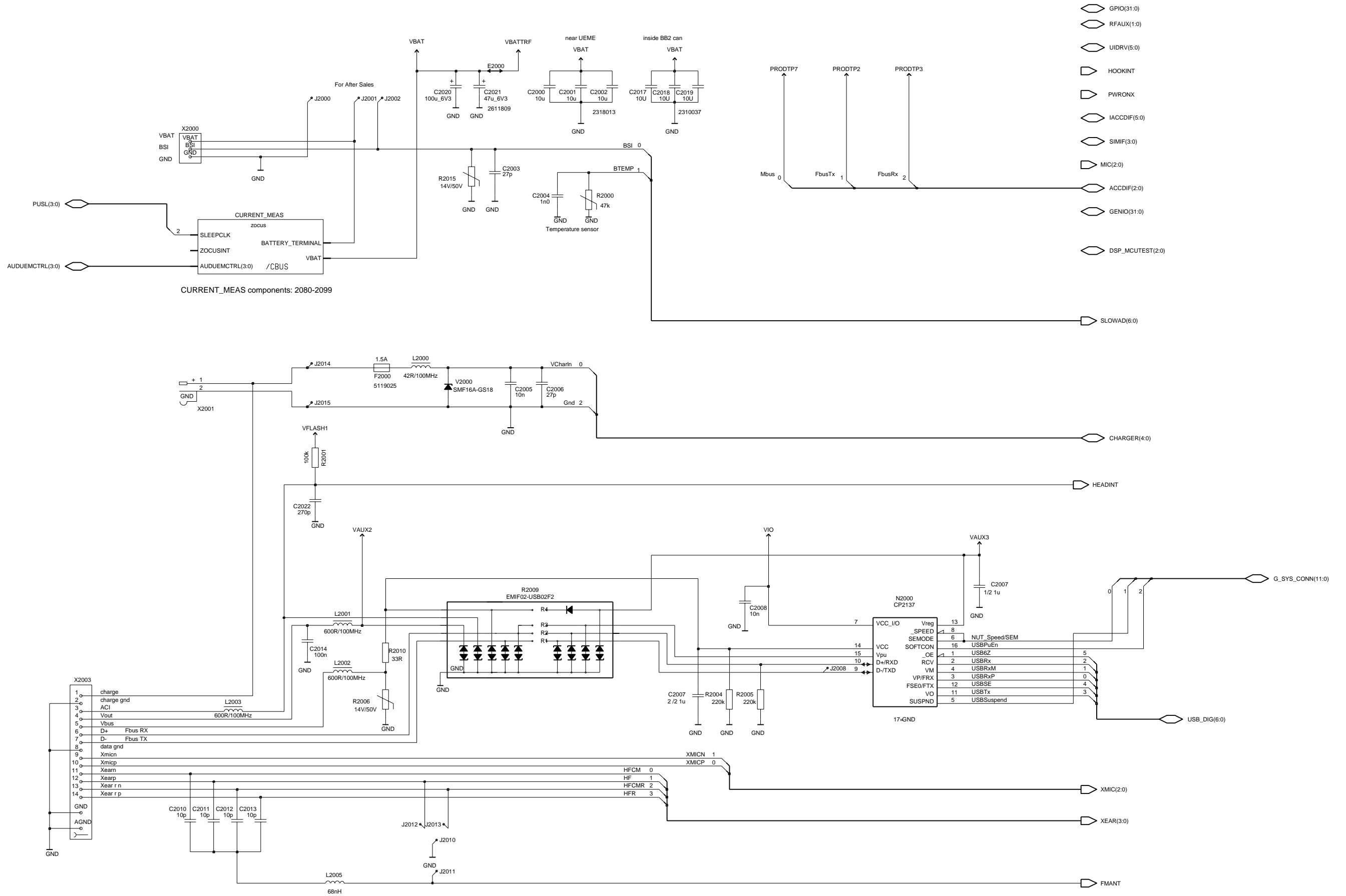

Br45 audio

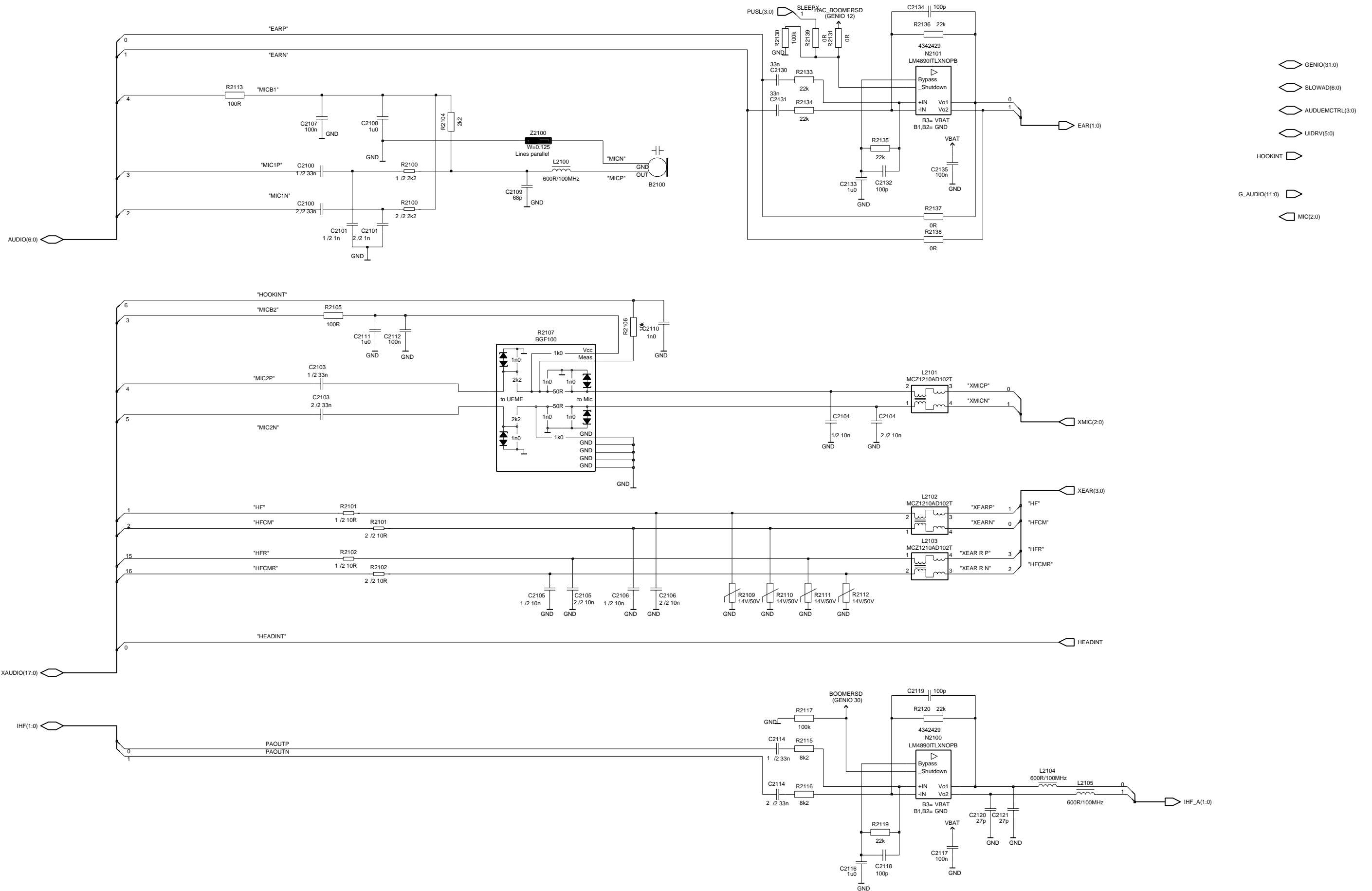

Current measure

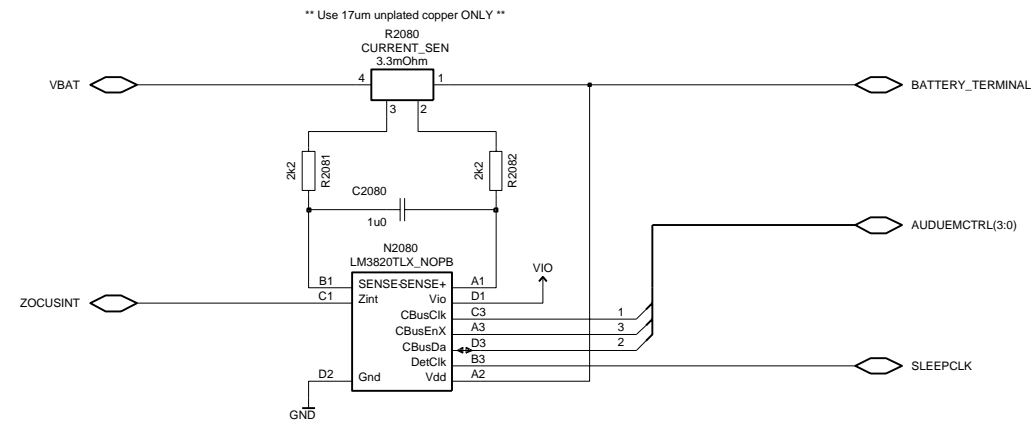

128Mbit NOR

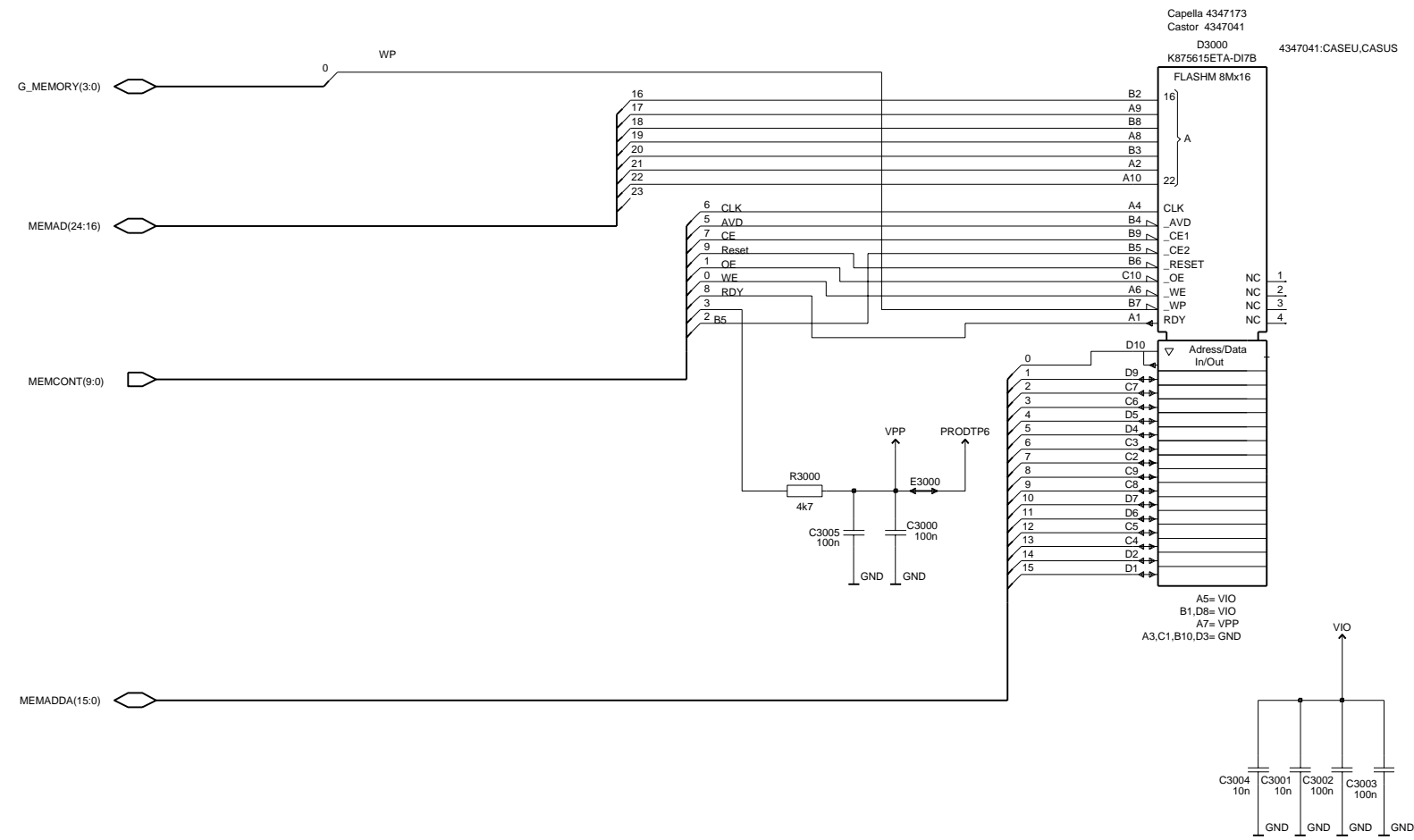
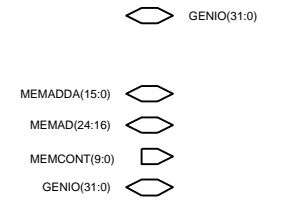

Keyboard UI

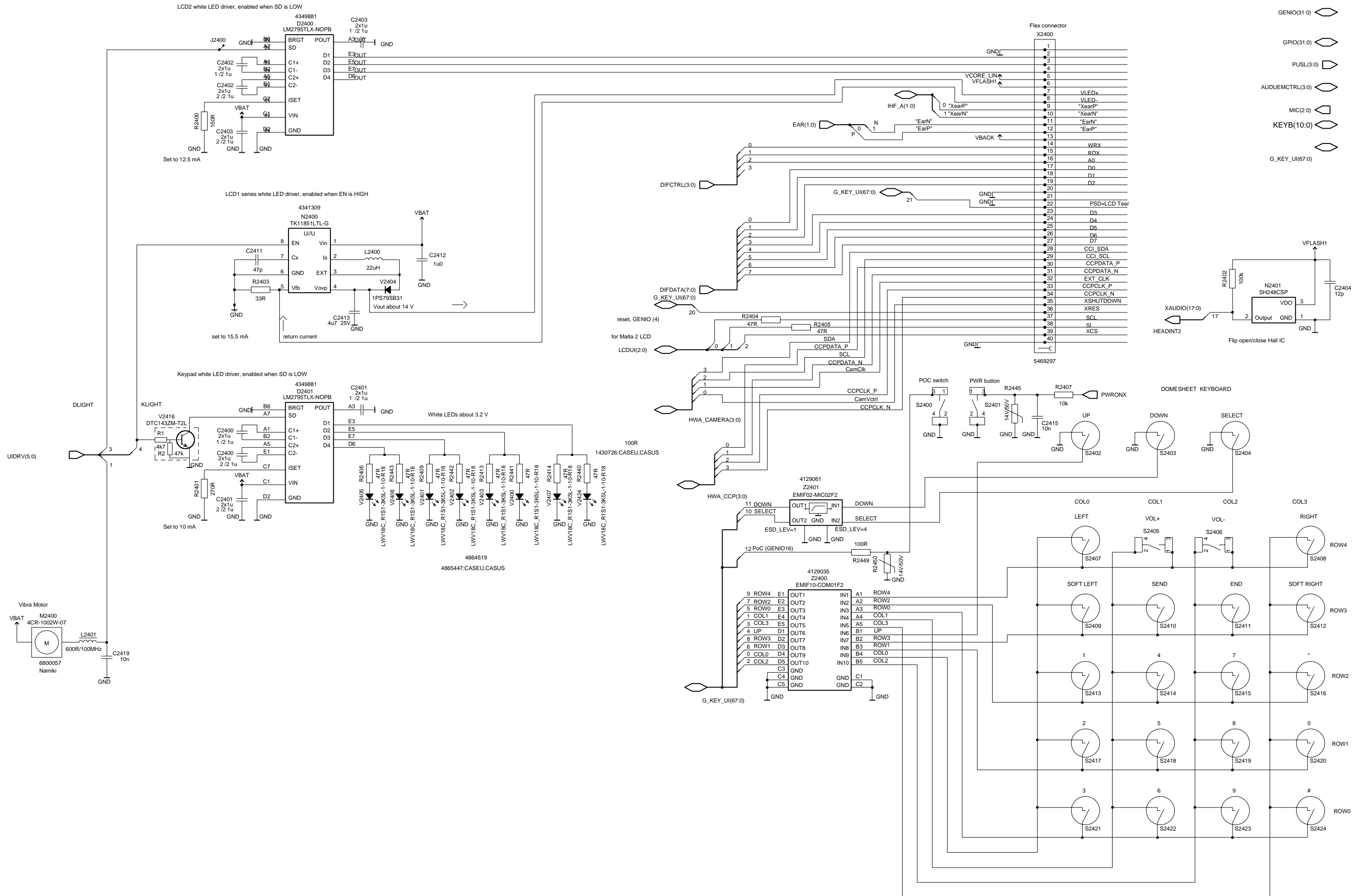

TIKU implementation

DCT4.0

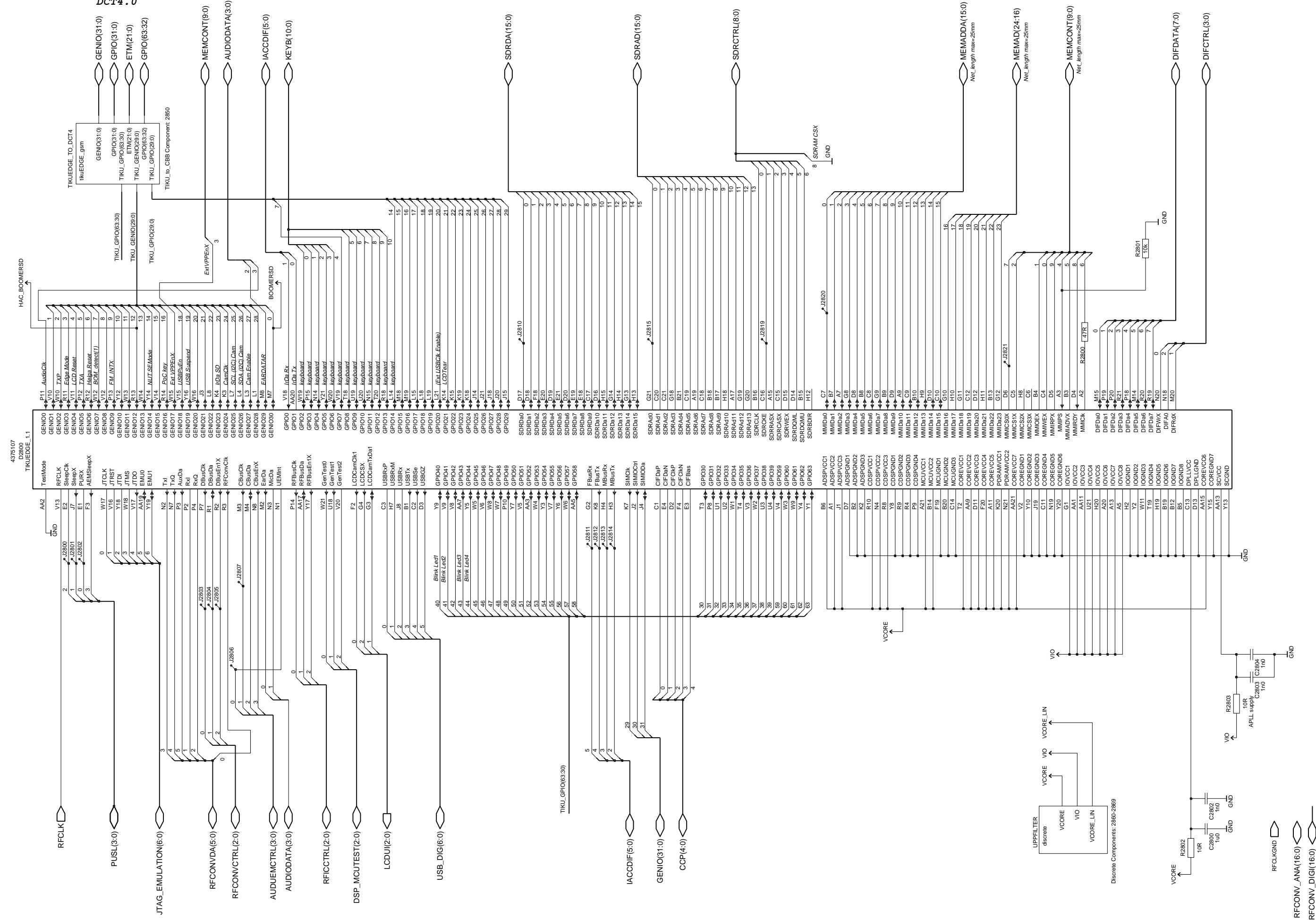

Discrete decoupling capacitors for TIKU

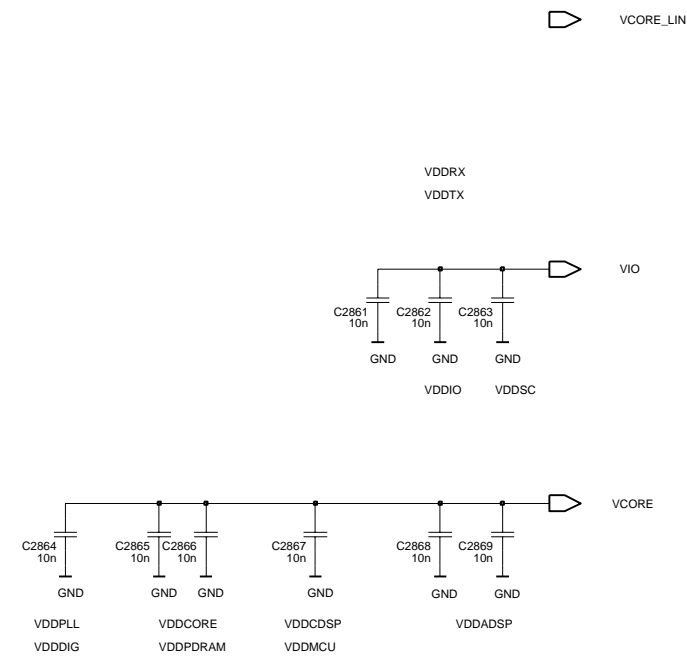

Copyright (C) Nokia Corporation. All rights reserved.
 THIS DRAWING IS PROTECTED BY COPYRIGHT AS AN UNPUBLISHED WORK.
 UNAUTHORIZED REPRODUCTION OF THIS DRAWING IS NOT PERMITTED.



Name	Discrete decoupling capacitors for Tiku	Appr	dd-mmm-yy
Assoc	DCT4 Common Baseband	Des.	M. Coombes 25-Feb-02
		Dr.	AKOURI 29-Jun-04

TIKU EDGE bus conversion sheet

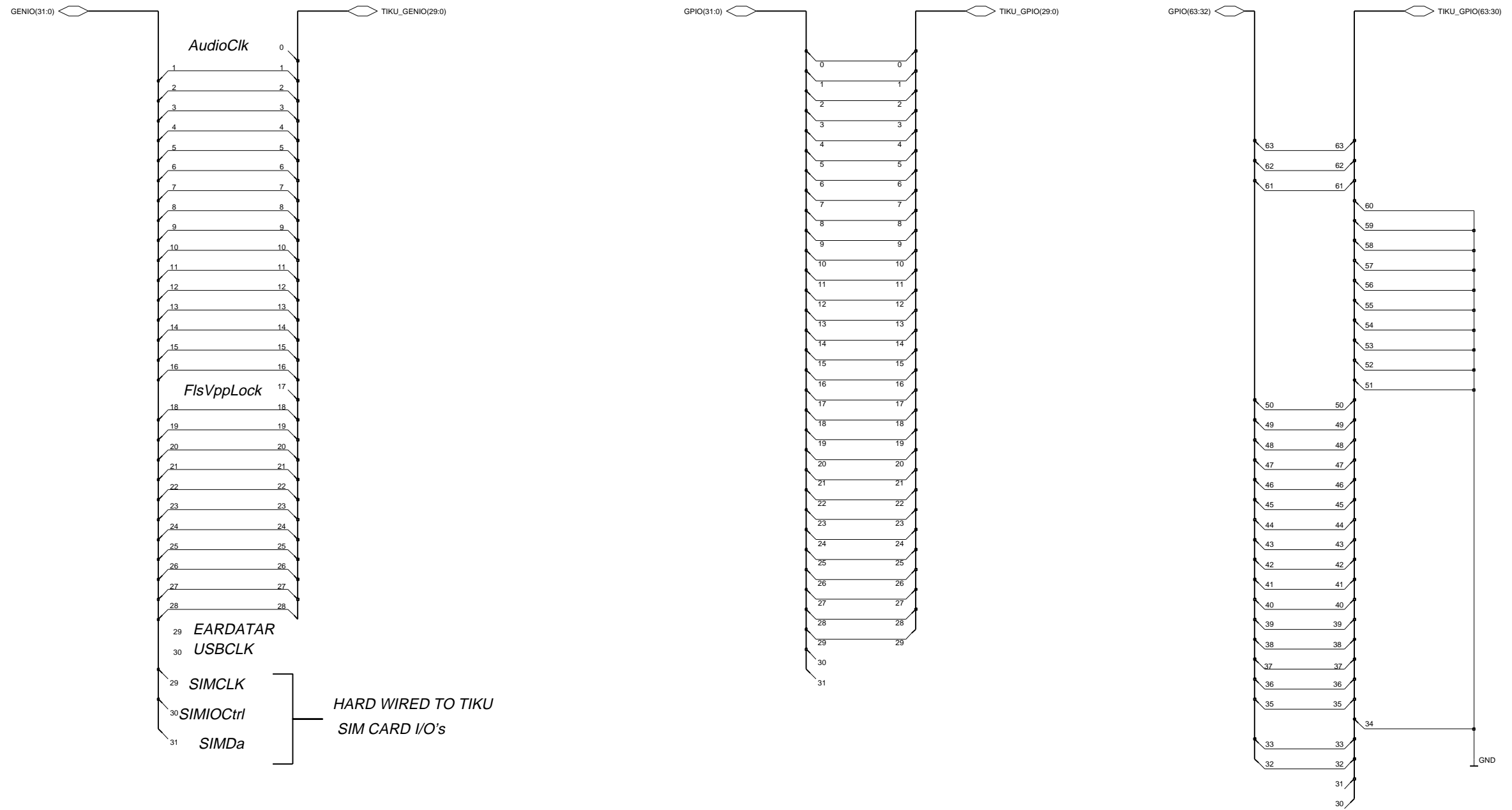

5 pine production test pattern

OUT

Module ID

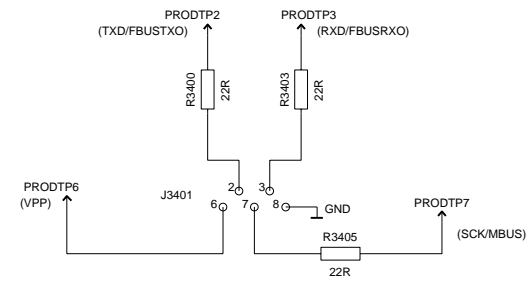

SIM reader

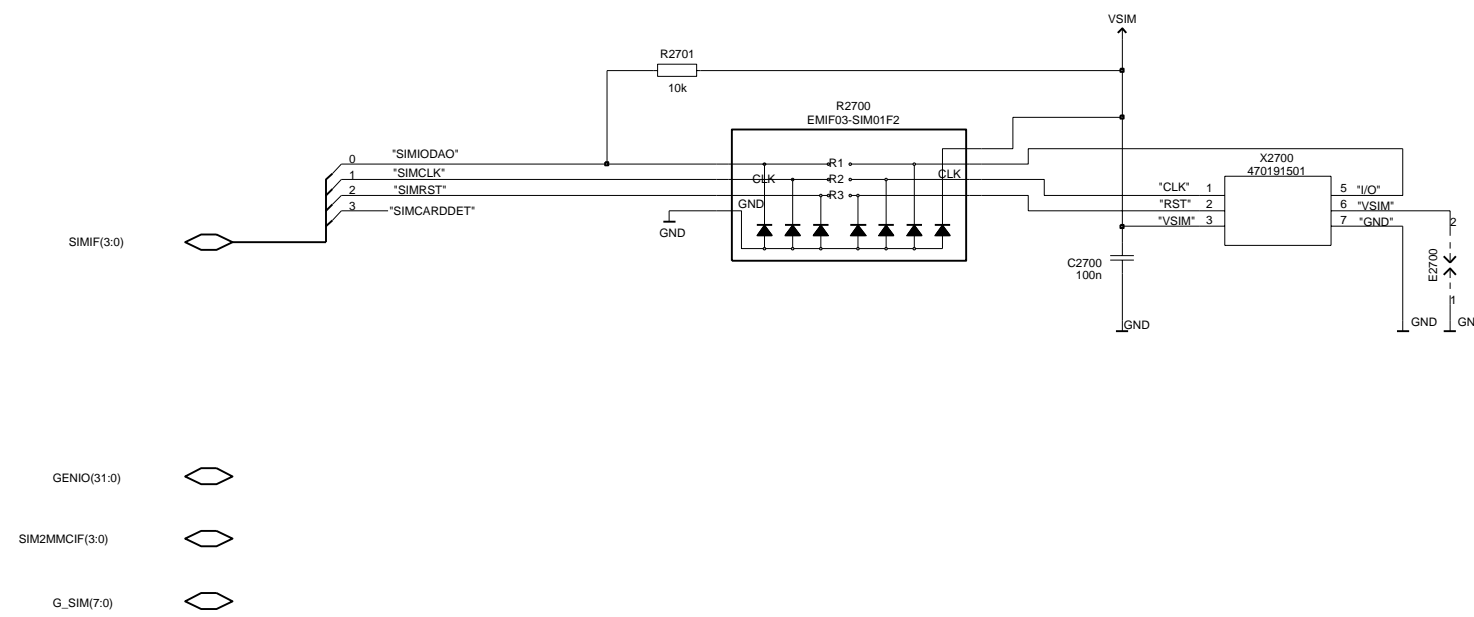

Upper block

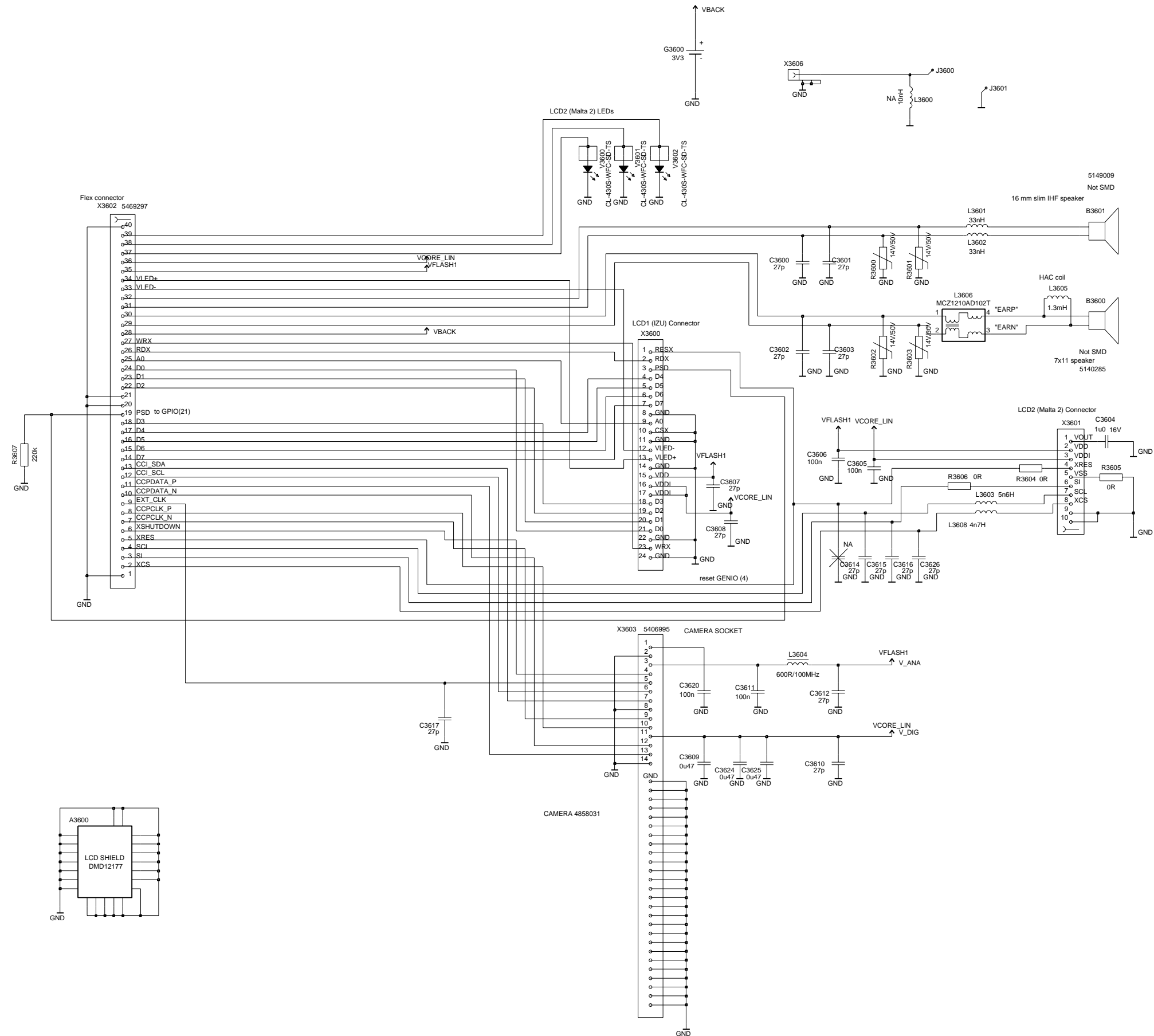

RM-8 assembly values diagram, bottom

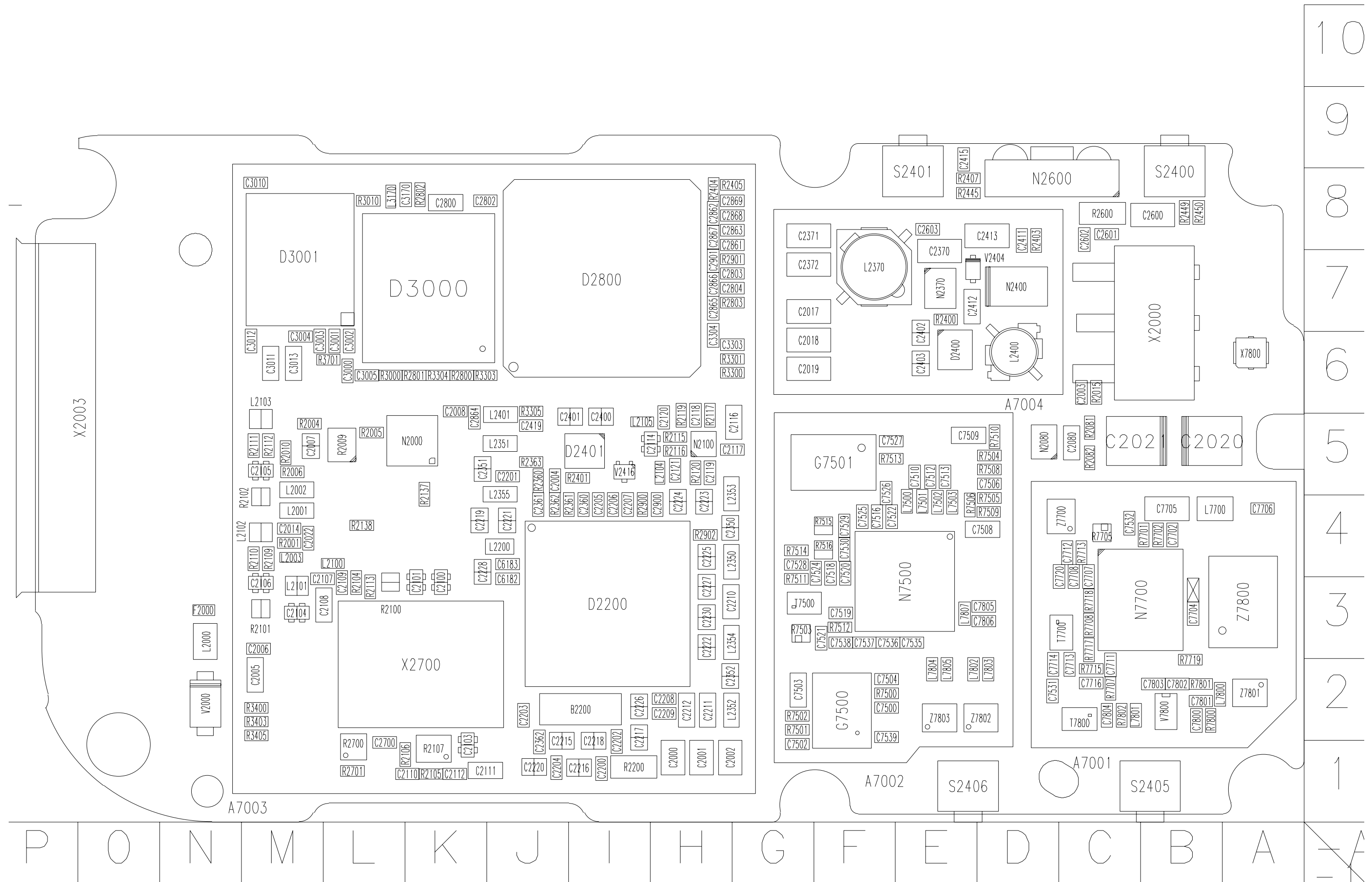

RM-8 assembly values diagram, top

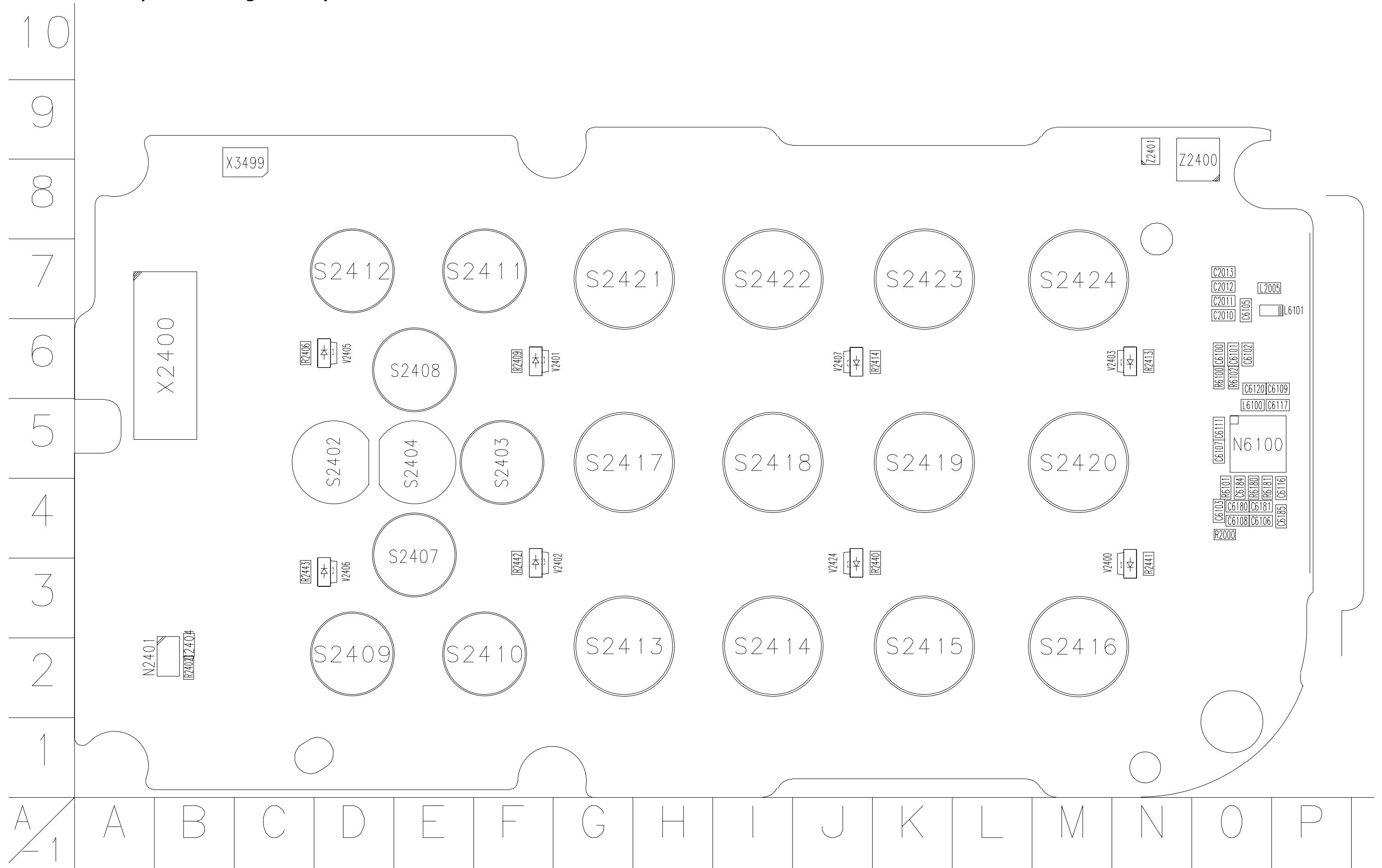

RM-47 assembly values diagram, bottom

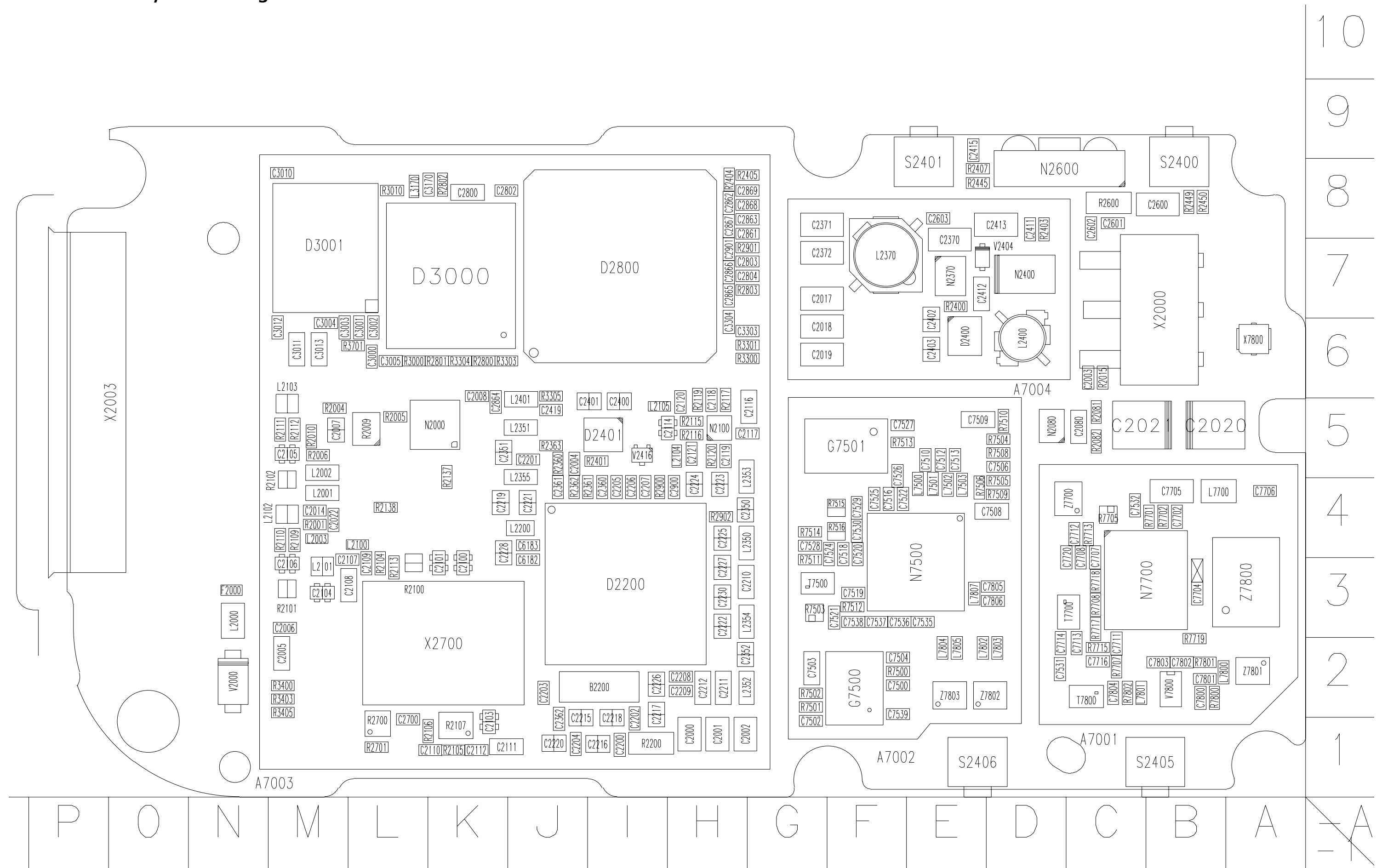

RM-47 assembly values diagram, top

