

N-Channel Logic Level Enhancement Mode Power MOSFET

MTB09N03H8

BV _{DSS}	30V
I _D	50A
R _{DS(on)(max)}	9.5mΩ

Description

The MTB09N03H8 is a N-channel enhancement-mode MOSFET, providing the designer with the best combination of fast switching, ruggedized device design, low on-resistance and cost effectiveness.

Features

- Single Drive Requirement
- Low On-resistance
- Fast Switching Characteristic
- Dynamic dv/dt rating
- Repetitive Avalanche Rated
- Pb-free lead plating and Halogen-free package

Symbol

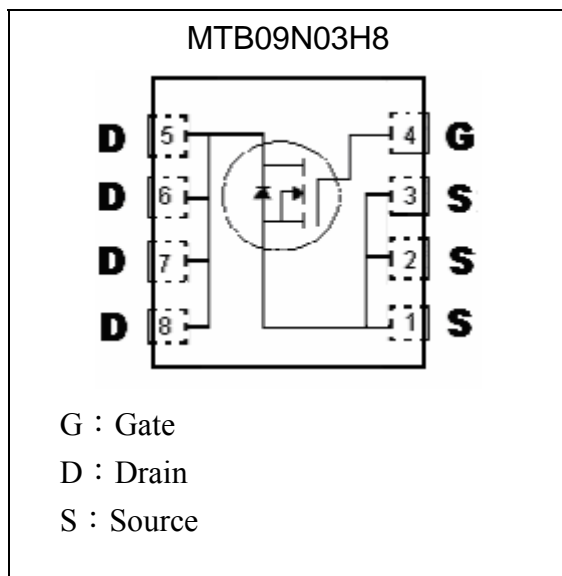

Outline

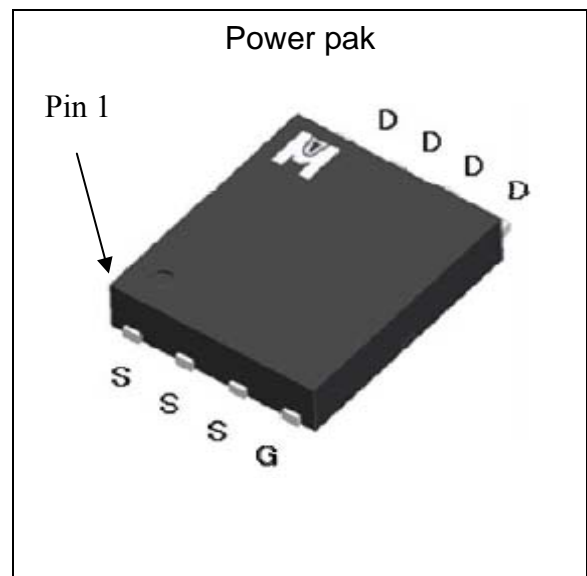



Absolute Maximum Ratings (Ta=25°C)

Parameter	Symbol	Limits	Unit	
Drain-Source Voltage	V _{DS}	30	V	
Gate-Source Voltage	V _{GS}	±20		
Continuous Drain Current @ T _c =25°C	I _D	50	A	
Continuous Drain Current @ T _c =100°C		35		
Pulsed Drain Current	I _{DM}	140 *1		
Avalanche Current	I _{AS}	37.5		
Avalanche Energy @ L=0.1mH, I _D =53A, R _G =25 Ω	E _{AS}	70	mJ	
Repetitive Avalanche Energy @ L=0.05mH	E _{AR}	15 *2		
Total Power Dissipation	P _D	T _c =25°C	60	W
		T _c =100°C	32	
Operating Junction and Storage Temperature Range	T _j , T _{stg}	-55~+175	°C	

100% UIS testing in condition of V_D=15V, L=0.1mH, V_G=10V, I_L=25A, Rated V_{DS}=25V N-CH

Thermal Data

Parameter	Symbol	Value	Unit
Thermal Resistance, Junction-to-case, max	R _{th,j-c}	2.5	°C/W
Thermal Resistance, Junction-to-ambient, max	R _{th,j-a}	50 *3	°C/W

- Note : 1. Pulse width limited by maximum junction temperature
 2. Duty cycle ≤ 1%
 3. Surface mounted on 1 in² copper pad of FR-4 board, 125°C/W when mounted on minimum copper pad

Characteristics (T_c=25°C, unless otherwise specified)

Symbol	Min.	Typ.	Max.	Unit	Test Conditions
Static					
BV _{DSS}	30	-	-	V	V _{GS} =0, I _D =250μA
V _{GS(th)}	1.0	1.7	3.0	V	V _{DS} = V _{GS} , I _D =250μA
G _{FS} *1	-	20	-	S	V _{DS} =5V, I _D =20A
I _{GSS}	-	-	±100	nA	V _{GS} =±20
I _{DSS}	-	-	1	μA	V _{DS} =24V, V _{GS} =0
	-	-	25		V _{DS} =20V, V _{GS} =0, T _j =125°C
I _{D(ON)} *1	50	-	-	A	V _{DS} =10V, V _{GS} =10V
R _{DS(ON)} *1	-	8	9.5	mΩ	V _{GS} =10V, I _D =25A
	-	15	19	mΩ	V _{GS} =4.5V, I _D =20A
Dynamic					
C _{iss}	-	2020	-	pF	V _{GS} =0V, V _{DS} =15V, f=1MHz
C _{oss}	-	275	-		
C _{rss}	-	160	-		

Characteristics (Tc=25°C, unless otherwise specified)

Symbol	Min.	Typ.	Max.	Unit	Test Conditions
Qg (VGS=10V) *1, 2	-	23	-	nC	VDS=15V, VGS=10V, ID=25A
Qg (VGS=4.5V) *1, 2	-	13	-		
Qgs *1, 2	-	4.7	-		
Qgd *1, 2	-	7.4	-		
td(ON) *1, 2	-	10	-	ns	VDS=15V, ID=20A, VGS=10V, RGS=2.7Ω
tr *1, 2	-	8	-		
td(OFF) *1, 2	-	30	-		
tf *1, 2	-	5	-		
Rg	-	1.7	-	Ω	VGS=15mV, VDS=0V, f=1MHz
Source-Drain Diode					
IS *1	-	-	50	A	
ISM *3	-	-	140		
VSD*1	-	-	1.3	V	IF=IS, VGS=0V
trr	-	22	-	ns	IF=IS, dIF/dt=100A/μs
Qrr	-	12	-	nC	

Note : *1.Pulse Test : Pulse Width ≤300μs, Duty Cycle≤2%
 *2.Independent of operating temperature
 *3.Pulse width limited by maximum junction temperature.

Recommended Soldering Footprint

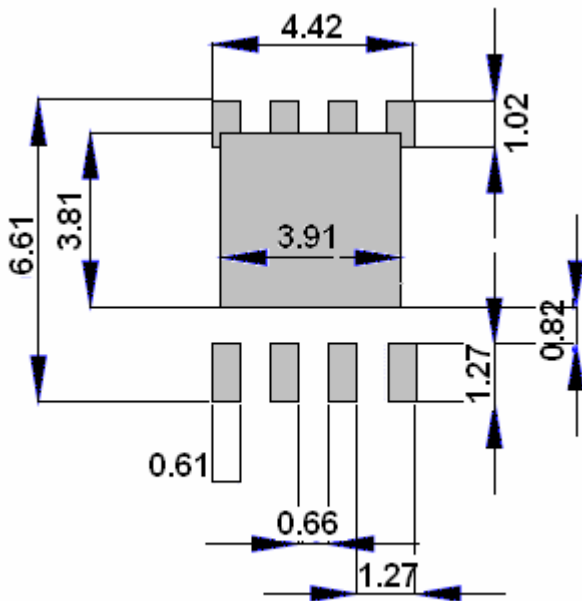

unit : mm

Characteristic Curves

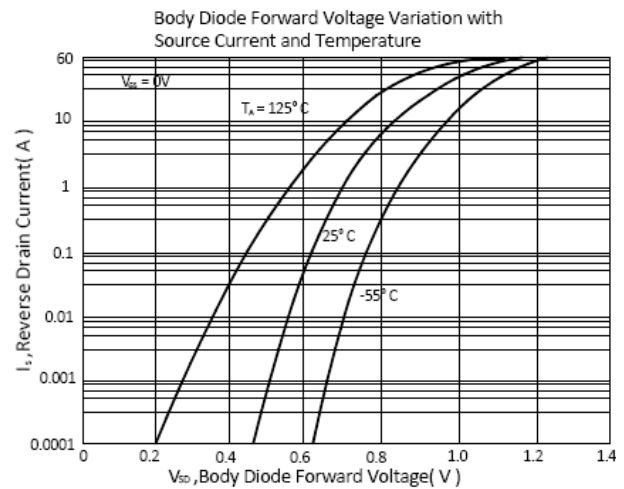
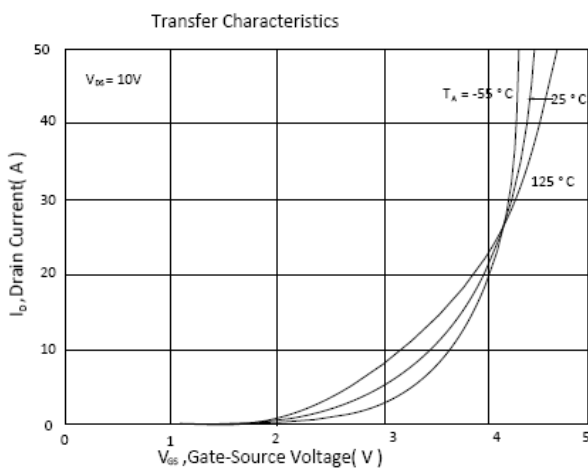
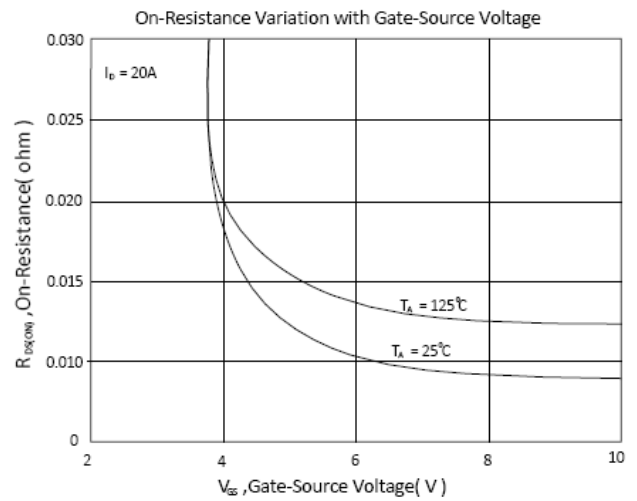
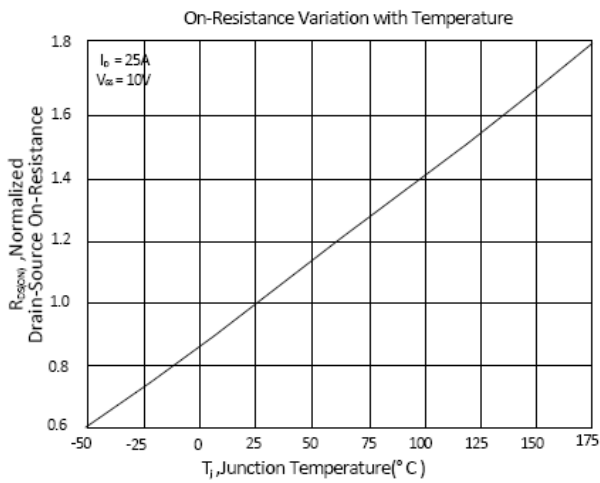
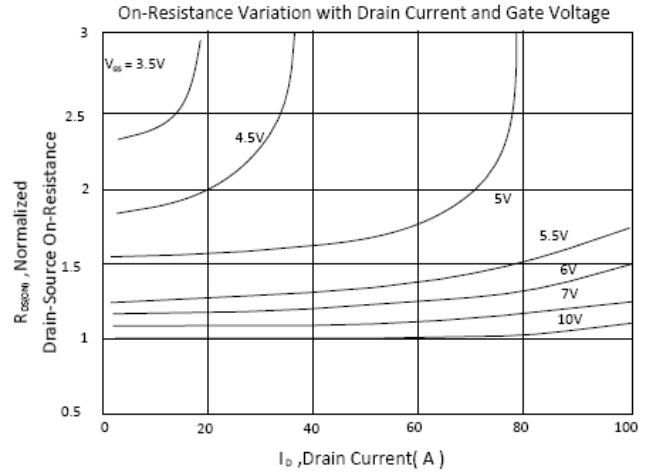
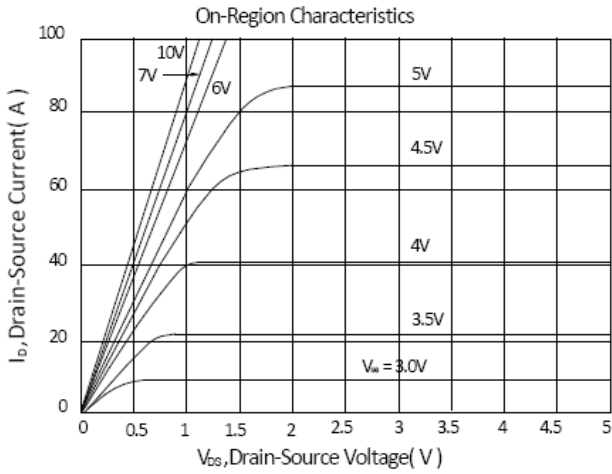



Characteristic Curves(Cont.)

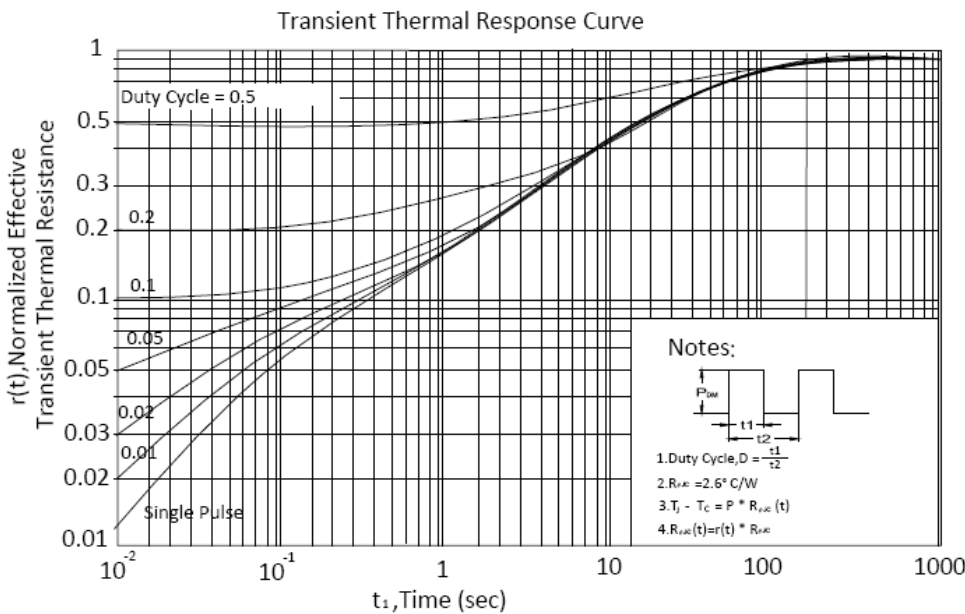
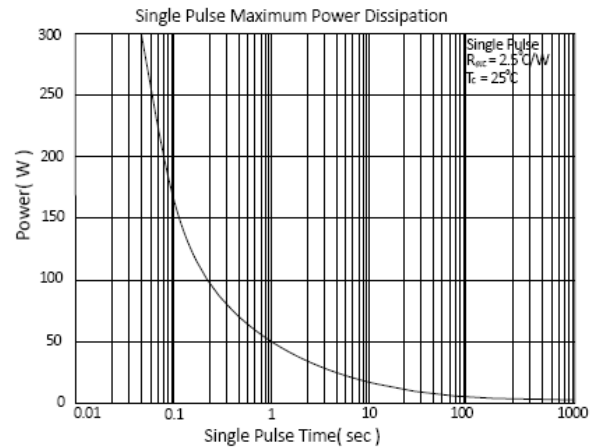
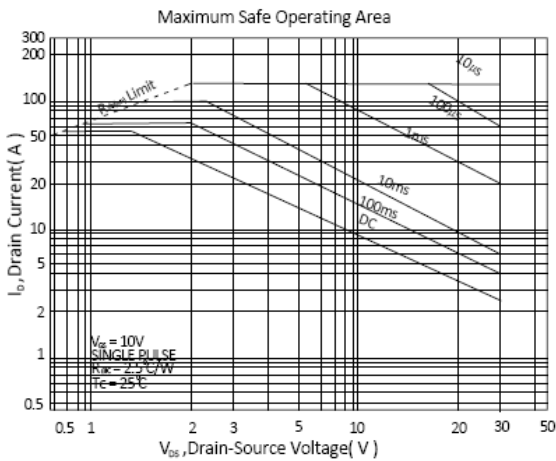
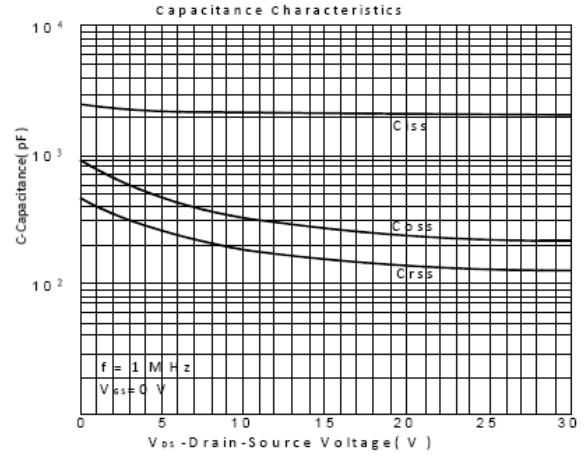
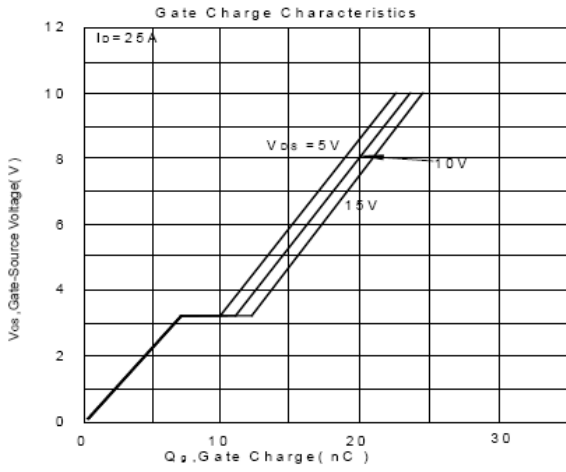

Power pak Dimension

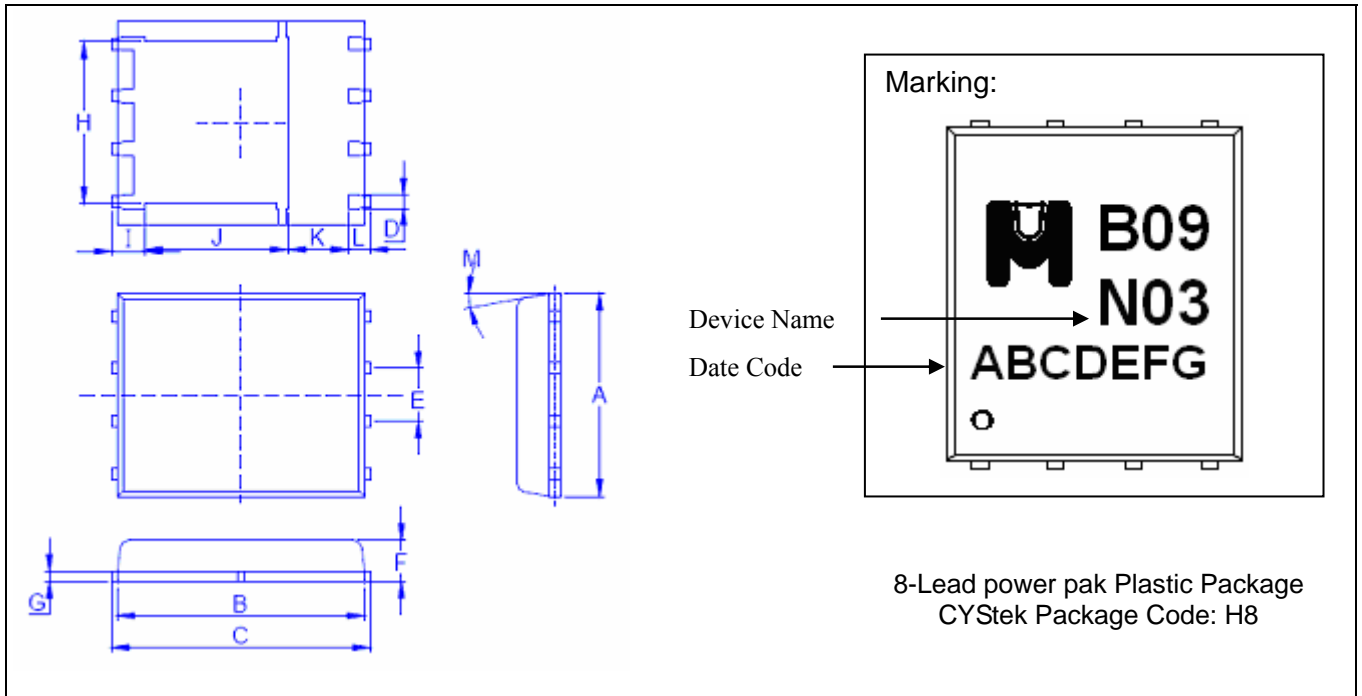

*: Typical

DIM	Inches		Millimeters		DIM	Inches		Millimeters	
	Min.	Max.	Min.	Max.		Min.	Max.	Min.	Max.
A	0.1890	0.1969	4.80	5.00	I	0.0161	0.0240	0.41	0.61
B	0.2244	0.2283	5.70	5.80	J	0.1331	0.1488	3.38	3.78
C	0.2323	0.2402	5.90	6.10	K	0.0433	-	1.10	-
D	0.0130	0.0201	0.33	0.51	L	0.0201	0.0280	0.51	0.71
E	0.0500*		1.27*		M	-	-	0°	12°
F	0.0354	0.0472	0.90	1.20					
G	0.0067	0.0118	0.17	0.30					
H	0.1445	0.1583	3.67	4.02					

Notes: 1.Controlling dimension: millimeters.
 2.Maximum lead thickness includes lead finish thickness, and minimum lead thickness is the minimum thickness of base material.
 3.If there is any question with packing specification or packing method, please contact your local CYStek sales office.

Material:

- Lead: pure tin plated
- Mold Compound: Epoxy resin family, flammability solid burning class: UL94V-0

Important Notice:

- All rights are reserved. Reproduction in whole or in part is prohibited without the prior written approval of CYStek.
- CYStek reserves the right to make changes to its products without notice.
- CYStek **semiconductor products are not warranted to be suitable for use in Life-Support Applications, or systems.**
- CYStek assumes no liability for any consequence of customer product design, infringement of patents, or application assistance.